

DE	Montageanleitung	2
FR	Instructions de montage	5
EN	assembly instructions	8
IT	Istruzioni per Installazione	11
ES	Instrucciones de montaje	14
NL	Handleiding	17
DK	Monteringsvejledning	20
PT	Manual de Instalação	23
PL	Instrukcja montażu	26
CS	Montážní návod	29
SK	Montážny návod	32
ZH	组装说明	35
RU	Инструкция по монтажу	38
HU	Szerelési útmutató	41
FI	Asennusohje	44
SV	Monteringsanvisning	47
LT	Montavimo instrukcijos	50
HR	Uputstva za instalaciju	53
TR	Montaj kılavuzu	56
RO	Instrucțiuni de montare	59
EL	Οδηγία συναρμολόγησης	62
SL	Navodila za montažo	65
ET	Raigaldusjuhend	68
LV	Montāžas instrukcija	71
SR	Uputstvo za montažu	74
NO	Montasjeveiledning	77
BG	Инструкция за употреба	80
SQ	Udhëzime rreth montimit	83
AR	تعليمات التجميع	88

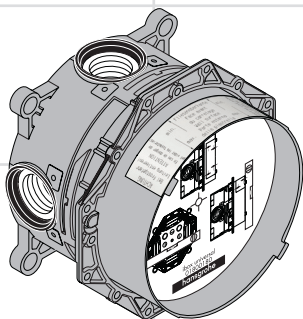

iBox universal

01800180





Rohmontage

Der rotationssymmetrische Grundkörper der iBox ist universell einsetzbar, horizontal wie vertikal. Ausgenommen bei der Montage der Wannensarmatur mit Sicherungskombination, hier ist nur der vertikale Einbau möglich. Da bei einem Defekt der Funktionsteile Wasser an der iBox austreten kann, muss die iBox über der Wanne montiert werden, damit austretendes Wasser in die Wanne abfließen kann!

Die iBox ist sowohl für Wannen- als auch für Brauseninstallation geeignet. Bei Einhand Wannenmischer / Thermostat mit Absperr- und Umstellventil ist der untere Abgang vorrangig. Wird nur ein Abgang benötigt, kann wahlweise der obere oder untere Abgang angeschlossen werden. Der nicht benötigte Abgang muss mit einem Stopfen abgedichtet werden.

Große Druckunterschiede zwischen den Kalt- und Warmwasseranschlüssen müssen ausgeglichen werden.

Grundkörper so einbauen, daß sich der Warmwasseranschluß links und der Kaltwasseranschluß rechts befindet.

Einbautiefe 80 mm bis 108 mm.

Verlängerung 25 mm: #13595000

Verlängerung 22 mm (bei geringer Einbautiefe):

#13593000 / #13596XXX / #13597XXX /
#15597000 / #19427000 / #97407XXX /
#98860000 / #13601000

Der Grundkörper kann entsprechend der baulichen Gegebenheiten montiert werden (Montagebeispiele siehe Seite 62 und 63).

A Installation auf die Wand.

B Installation auf die Wand. Hier mit flexiblen Abstandhalter durch 10er Stockschrauben.

C Montage auf Trägersystem.

D Installation auf Fertighaus-Montageplatten oder Fertigzellen.

E Installation direkt in die Wand.

F Installation mit Montageschienen-set #96615000

Installationsbeispiele mit Maßangaben und Leitungsdimensionierung sind ab Seite 68 zu finden. Die Erläuterung der verwendeten Symbole auf Seite 67.

Die in der Montageanleitung angegebenen Montage-maße sind ideal für Personen von ca. 1800 mm Körpergröße und müssen gegebenenfalls angepasst werden. Hierbei ist darauf zu achten, dass sich bei geänderter Montagehöhe die Mindesthöhe ändert und die Änderung der Anschlussmaße berücksichtigt werden müssen. Die Verbrauchswerte wurden praxisnah mit den dazugehörigen Armaturen (Thermostat/Mischer/Unterputzventil) gemessen.

Montage-Tipp

Um Anschlussstücke einzudrehen, die iBox mittels eines Rohrstücks in den Schraubstock einspannen.

Spülen

Komplette Installation gemäß DIN 1988 / EN 1717 spülen. Die Pfeile auf dem Spülblock zeigen, welcher Zulauf mit welcher Abgangsleitung verbunden ist, z. B. Kaltwasser mit Abgang 1 und Warmwasser mit Abgang 2. Falls nur ein Abgang benötigt wird, muß nach dem ersten Spülvorgang der Spülblock um 90° gedreht werden.

iBox in Kombination mit einer Exafill Wanneneinlauf mit Ab- und Überlaufgarnitur (siehe Seite 66)

Technische Daten

Betriebsdruck:	max. 1 MPa
Empfohlener Betriebsdruck:	0,1 - 0,5 MPa
Prüfdruck:	1,6 MPa
(1 MPa = 10 bar = 147 PSI)	
Heißwassertemperatur:	max. 80°C
Empfohlene Heißwassertemperatur:	65°C
Anschlussmaße:	G ^{3/4}
Anschlüsse:	kalt rechts - warm links
Freier Durchfluss bei 0,3 MPa:	
Brausemischer:	32 l/min
Thermostat:	43 l/min
Thermostat mit Absperrventil:	26 l/min
Thermostat mit Absperr- und Umstellventil:	26 l/min
Thermostat Highflow:	58 l/min
iControl:	30 l/min
Wannenmischer:	31 l/min // 24 l/min
Wannenmischer mit integrierter Sicherungskombination:	25 l/min // 24 l/min



Montage siehe Seite 89



X

Mitte Badewanne / Mitte Duschwanne



Unterputz-Ventil

Y

Maß Y = Mitte Schlauchanschlussbogen bis Mitte Wanneneinlauf dividiert durch 2 (eventuell dem Fliesenraster anpassen).



Quattro Vierwegeumstellung

Quattro



Warmwasser



Trio Universal Absperr- und Umstellventil



Kaltwasser

Trio



Ab • ist die Funktion gewährleistet.



Wanneneinlauf



In diesem Bereich ist eine Wandverstärkung notwendig.



Der nicht benötigte Abgang muss mit einem Blindstopfen abgedichtet werden. (DN 20 3/4")



Nur ein Verbraucher möglich, nicht zwei gleichzeitig.



Die Abfließleistung muss mehr als 50 l/min betragen.

> 50 l/min



Wasserleitungen für Seitenbrausen mit Gefälle verlegen.



Ablauf

Raindrain



Spülblock kpl. #15956000, nicht im Lieferumfang enthalten



iBox in Kombination mit einer Exafill Wanneneinlauf mit Ab- und Überlaufgarnitur (siehe Seite 66)

Exafill



Montage siehe Seite 89



Montage de base

La pièce de base rotative symétrique de l'iBox a une possibilité de montage universel, horizontal comme vertical. Sauf pour le montage d'u mitigeur bain-douche avec disconnecteur ou là le montage vertical seulement est possible. Parceque l'eau pourrait fuir de l'iBox en cas de défaillance des pièces de fonctionnement, l'iBox doit être monté au dessus de la baignoire pour que la fuite puisse s'écouler dans la baignoire.

L'iBox est appropriée aussi bien pour les baignoires que pour les douches. Pour un mitigeur bain/douche / mitigeur thermostatique avec robinet d'arrêt et inverseur, la sortie inférieure est prioritaire. Si une seule sortie est nécessaire, il est possible de raccorder au choix soit la sortie supérieure, soit la sortie inférieure. La sortie non utilisée doit être condamnée avec un bouchon.

Il est conseillé d'équilibrer les pressions de l'eau chaude et froide.

Monter la pièce de base pour que l'eau chaude arrive sur le côté gauche et l'eau froide sur le côté droit.

Profondeur d'encastrement: 80 mm à 108 mm.

jeu de rallonge 25 mm: #13595000

Rallonge de 22 mm (pour profondeur de montage trop faible): #13593000 / #13596XXX / #13597XXX / #15597000 / #19427000 / #97407XXX / #98860000 / #13601000

La pièce de base peut être installée selon les différentes possibilités voir pages 62 et 63).

- A** Installation au mur.
- B** Installation au mur avec une vis de distance.
- C** Montage sur système support.
- D** Installation sur des panneaux de montage préfabriqués.
- E** Installation directement dans le mur.
- F** Installation avec rail de fixation #96615000

Des exemples d'installation avec indication de cotes et dimensions des conduites sont fournis à partir de la page 68. Les symboles utilisés sont expliqués à la page 67.

Les dimensions d'installation indiquées dans la notice de montage sont idéales pour des personnes d'une taille de 1800 mm environ et doivent être ajustées selon le cas. Tenir compte pour cela du fait qu'un changement de hauteur modifie la hauteur minimum et que la modification des cotes de raccord doit entrer en ligne de compte. Les valeurs de consommation ont été mesurées dans la pratique, avec les robinetteries correspondantes (thermostat/mélangeur/vanne sous crépi)

Exemple de montage

Pour monter les différents raccords, on peut fixer l'iBox grâce à un tuyau et un étai.

Rinçage

Rincer l'installation complète conformément à la réglementation et aux normes. Les flèches sur le bloc de rinçage indiquent l'arrivée et la sortie qui doivent être raccordés, par exemple eau froide avec sortie 1 et eau chaude avec sortie 2. Si on utilise seulement une sortie, on devra après le premier rinçage tourner de 90° le bloc de rinçage.

iBox en combinaison avec un remplissage exafill avec mécanisme de vidage et de trop plein (voir pages 66)

Informations techniques

Pression de service autorisée:	max. 1 MPa
Pression de service conseillée:	0,1 - 0,5 MPa
Pression maximum de contrôle:	1,6 MPa
(1 MPa = 10 bar = 147 PSI)	
Température d'eau chaude:	max. 80 °C
Température recommandée:	65 °C
Dimension d'arrivée:	G $\frac{3}{4}$
Raccordement:	froide à droite - chaude à gauche
Débit libre à 0,3 MPa:	
Mitigeur douche:	32 l/min
Mitigeur thermostatique:	43 l/min
Mitigeur thermostatique avec robinet d'arrêt:	26 l/min
Mitigeur thermostatique avec robinet d'arrêt et inverseur:	26 l/min
Mitigeur thermostatique Highflow:	58 l/min
iControl:	30 l/min
Mitigeur bains-douches:	31 l/min // 24 l/min
Mitigeur bains-douches avec disconnecteur:	25 l/min // 24 l/min



Montage voir pages 89



X

Centre de la baignoire / Centre cuvette de douche



Robinet d'arrêt encastré

Y

Dimension Y = du centre raccord coudé de douche au centre bec déverseur divisé par 2 (éventuellement s'adapter au carrelage).



Quattro

Quattro inverseur quatre voies



Eau chaude



Trio Robinet d'arrêt avec inverseur



Eau froide



Trio



A partir de • le fonctionnement est garanti.



Bec déverseur



Le mur n'a pas besoin d'être renforcé à cet endroit



La sortie non utilisée doit être condamnée avec un bouchon laiton. (DN 20 3/4")



Une seule utilisation possible, pas les deux ensemble.



Le débit de vidage doit être supérieur à 50 l/min.

> 50 l/min



La tuyauterie des douchettes latérales à installer avec une pente.



Vidage



Raindrain



bloc d'essai #15956000, ne fait pas partie de la fourniture



Exafill

iBox en combinaison avec un remplissage exafill avec mécanisme de vidage et de trop plein (voir pages 66)



Montage voir pages 89



Concealed installation

The rotation symmetrical body is horizontal and vertical usable. Only exception installing the bath-shower mixer with integrated safety combination. In this case only a vertically installation is possible. Install the iBox always above the bath-tup. If parts of the iBox will broken, the water can flow in there!

The iBox is suitable for both bath and shower applications. When using the bath-shower mixer / thermostatic mixer with shut-off and diverter unit outlet, the lower outlet must have priority. If you need only one outlet, choose either the top or the bottom outlet and connect it. Close the unused outlet with a plug.

The hot and cold supplies must be of equal pressures.

Install body with the hot water supply left and cold water supply right.

Depth of fitting: 80 mm to 108 mm.

extension 25 mm: #13595000

Extension Set 22 mm (when wall is not deep enough):
#13593000 / #13596XXX / #13597XXX /
#15597000 / #19427000 / #97407XXX /
#98860000 / #13601000

The iBox can depending on the building application be mounted in different ways, Installation examples please see page 62 and 63.

- A** Direct wall installation.
- B** Direct wall installation with 10 mm adjustable mounting studs.
- C** Installation on carrier system.
- D** Hollow wall installation.
- E** Brick wall installation.
- F** Installation with fixation set #96615000

Installation examples with measurements and pipe dimensions can be found starting on page 68. The used symbols are explained on pages 67.

The installation dimensions stated in these installation instructions are ideal for people of approximately 1800 mm in body height. The dimensions can be altered if required. In this case, pay attention to the fact that a change of installation height will also change the minimum height, and that the altered mounting dimensions must be taken into consideration. The consumption was measured in combination with the appropriate fittings (thermostat/mixer/in-wall valve) to reflect actual application in practice.

Installation tip

To install the supply pipes, fix the iBox with a pipe in a vice.

Flush piping system

To complete the installation flush out both hot and cold water supply. The arrows on the flush body are showing, which inlet is connected with which outlet, for example cold water supply with outlet 1 and hot water supply with outlet 2. If only one outlet is in use, after first flushing the flush body must turned about 90°.

iBox in combinaton with an Exafill bath filler with overflow and waste (see page 66)

Technical Data

Operating pressure:	max. 1 MPa
Recommended operating pressure:	0,1 - 0,5 MPa
Test pressure:	1,6 MPa
(1 MPa = 10 bar = 147 PSI)	
Hot water temperature:	max. 80 °C
Recommended hot water temp.:	65 °C
Centre distance:	G $\frac{3}{4}$
Connections:	cold right - hot left
Rate of flow by 0,3 MPa:	
Shower mixer:	32 l/min
Thermostatic mixer:	43 l/min
Thermostatic mixer with shut off unit:	26 l/min
Thermostatic mixer with shut off and diverter unit:	26 l/min
Thermostatic mixer Highflow:	58 l/min
iControl:	30 l/min
Bath-shower mixer:	31 l/min // 24 l/min
Bath-shower mixer with integrated safety combination:	25 l/min // 24 l/min



Assembly see page 89



X

Center bath tub / Center shower tub



Shut off valve

Y

Dimension Y = center of hose wall outlet elbow to centre of bath filler divided by 2 (match to tile layout if applicable).



Quattro 4-Way Diverter Valve

Quattro



Warm water



Trio 2-Way Diverter Valve with integrated Shut-off valve



Cold water

Trio



From • the function is guaranteed.



Bath Spout



The wall must be reinforced in this area.



Plug the unused outlet. (DN 20 3/4")



Only one function is possible.



The waste drain performance must be more than 50 l/min.

> 50 l/min



Install water pipes for body showers with a gradient.



Waste

Raindrain



flushing unit complete #15956000, order as an extra



iBox in combination with an Exafill bath filler with overflow and waste (see page 66)

Exafill



Assembly see page 89



Installazione della tubazione

La rotazione simmetrica del corpo permette di raccordarsi agli attacchi sia verticalmente che orizzontalmente. Set vasca/doccia con valvola antiriflusso, è obbligatorio. Solo in caso di installazione del raccordarsi agli attacchi verticalmente. Installare sempre l'iBox sopra alla vasca o al piatto doccia, poiché in caso di fuoriuscita d'acqua questa verrà convogliata allo scarico.

L'iBox è adatto tanto ad installazioni per vasca quanto per doccia. Per i miscelatori monocomando per vasca / termostatico con rubinetto di arresto e deviatore l'uscita inferiore ha la prevalenza. Se si utilizza solo un'uscita, a scelta può essere collegata l'uscita superiore o quella inferiore. L'uscita non utilizzata deve essere chiusa con un tappo.

Attenzione! Compensare le differenze di pressione tra i collegamenti dell'acqua fredda e dell'acqua calda.

Installare il corpo incasso in modo tale che il raccordo dell' acqua calda si trovi a sinistra e il raccordo dell' acqua fredda a destra.

Profondità d'installazione: da 80 mm a 108 mm.

Prolunga 25 mm: #13595000

Prolunga 22 mm x set esterno (in caso di incasso troppo esterno al muro): #13593000 / #13596XXX / #13597XXX / #15597000 / #19427000 / #97407XXX / #98860000 / #13601000

Il corpo incasso può essere installato conformemente alle condizioni edilizie, vedi esempi di installazione alle pagg. 62 e 63.

A Installazione a muro.

B Installazione a muro. Qui con la regolazione della distanza (vite nr 10).

C Montaggio su struttura portante.

D Installazione per bagni prefabbricati.

E Installazione diretta a muro.

F Installazione con pareti in cartongesso #96615000

Esempi per l'installazione con indicazioni delle misure e per le dimensioni delle tubature sono riportati a partire della pagina 68. Per il significato dei simboli impiegati si vedano le pagina 67.

Le quote di montaggio indicate nelle istruzioni di montaggio sono ideali per persone grandi circa 1800 mm e eventualmente vanno adattate. A ciò bisogna fare attenzione, che ad altezza di montaggio cambiata l'altezza minima necessaria indicata cambia e che bisogna considerare la modifica delle quote di collegamento. I valori di consumo sono stati misurati nella pratica con le armature appartenenti (Termostato/Miscelatore/Valvola sotto-intonaco).

Suggerimento per l' installazione

Per avvitare i raccordi bloccare l' iBox nella morsa come illustrato.

Lavaggio della tubazione

Eeguire il lavaggio della tubazione come suggerisce la normativa DIN 1988 / EN 1717. Indicare sulla copertura del corpo quale alimentazione è collegata a quale tubo di uscita (ad es. acqua fredda con uscita 1 e acqua calda con uscita 2). Nel caso in cui si sia utilizzata una sola uscita, dopo il primo processo di lavaggio la copertura deve essere ruotata di 90° per eseguire il secondo processo di lavaggio.

iBox in combinazione con Exafill scarico con erogazione al troppo pieno (vedi pagg. 66)

Dati tecnici

Pressione d'uso:	max. 1 MPa
Pressione d'uso consigliata:	0,1 - 0,5 MPa
Pressione di prova:	1,6 MPa
(1 MPa = 10 bar = 147 PSI)	
Temperatura dell'acqua calda:	max. 80 °C
Temp. dell'acqua calda consigliata:	65 °C
Distanza di raccordo:	G ³ / ₄
Raccordi:	fredda a destra - calda a sinistra
Portata a 0,3 MPa:	
Miscelatore doccia:	32 l/min
Termostatico:	43 l/min
Termostatico con rubinetto di arresto:	26 l/min
Termostatico con rubinetto di arresto e deviatore:	26 l/min
Termostatico Highflow:	58 l/min
iControl:	30 l/min
Miscelatore vasca/doccia:	31 l/min // 24 l/min
Miscelatore vasca incasso con sicurezza (valv. antiriflusso):	25 l/min // 24 l/min





X

Centro vasca / Centro piatto doccia



Rubinetto di arresto

Y

Valore Y = Dal centro del raccordo a muro al centro della bocca di erogazione vasca diviso 2 (eventualmente adattare alla dimensione delle piastrelle).



Quattro Valvola a quattro vie

Quattro



Acqua calda



Trio arresto/deviatore



Acqua fredda

Trio



Dal • si garantisce la funzionalità.



Bocca di erogazione



In questa zona è necessario un rinforzo della parete.



Chiudere con un tappo l'uscita non utilizzata. (DN 20 3/4")



Non è possibile utilizzare due utenze in contemporanea.



La portata di scarico deve essere superiore a 50 l/min.

> 50 l/min



Posizionare i tubi alle doccette laterali con una leggera pendenza.



Scarico

Raindrain



placca frontale #15956000, non contenuto nel volume di fornitura



iBox in combinazione con Exafill scarico con erogazione al troppo pieno (vedi pagg. 66)

Exafill





Montaje del cuerpo empotrado

El cuerpo base del iBox universal se puede montar en plano horizontal y vertical. La única excepción se da al instalar el mezclador de baño/ducha con combinación de seguridad integrada. En tal caso, solo la instalación vertical es posible. Instalar el iBox siempre por encima de la bañera ya que, si se rompiera alguna pieza del iBox, el agua estaría contenida.

El iBox puede ser utilizado tanto en una instalación de bañera como de ducha. En mezcladores de bañera monomando, con termostato con válvula de cierre e inversión, tiene prioridad la salida inferior. Si solo se necesita una salida se puede conectar tanto en la salida superior como en la inferior. La salida que no se utilice deberá estar cerrada con un tapón.

Grandes diferencias de presión en servicio entre agua fría y agua caliente deben equilibrarse.

Montar el cuerpo de tal manera que el agua caliente está a la izquierda y el agua fría está en la derecha.

Profundidad de montaje 80 mm a 108 mm.

Prolongación 25 mm: #13595000

Alargo 22 mm (en caso de pared delgada):

#13593000 / #13596XXX / #13597XXX /

#15597000 / #19427000 / #97407XXX /

#98860000 / #13601000

El cuerpo empotrado puede ser colocado según los ejemplos expuestos en las páginas 62 y 63.

- A** Instalación directamente sobre la pared.
 - B** Instalación sobre la pared. Aquí con soportes de distanciamiento y tornillos de acero de 10.
 - C** Montaje en el sistema portante.
 - D** Instalación en placas murales prefabricados.
 - E** Instalación directa en la pared.
 - F** Instalación con set de guías de fijación #96615000
- A partir de la página 68 puede consultar ejemplos de instalación y dimensionamiento de la conducción. La aclaración de los símbolos utilizados en las páginas 67.

Las medidas indicadas en las instrucciones de montaje resultan ideales para personas de 1800 mm de altura, por lo que deberán ajustarse siempre que sea necesario. En este sentido, es importante tener en cuenta que, en caso de modificación de la altura de montaje, cambia la altura mínima y habrá que adaptar las medidas de conexión. Los valores de consumo han sido medidos en la práctica con los grifos correspondientes (termostato/mezclador/válvula empotrada).

Recomendación

Para enroscar los codos de conexión, fijar el iBox universal mediante un trozo de tubería en un tornillo de banco.

Purga de la tubería

Purgar la instalación según la normativa DIN 1988/ EN 1717. Las flechas en el bloque de purgar indican qué entrada está conectada con qué salida. Si solamente utilizará una salida se ha de girar el bloque de purgar en 90° después del primer proceso de purgar.

iBox universal en combinación con Exafill, vaciador automático con chorro incorporado y rebosadero (ver página 66)

Datos técnicos

Presión en servicio:	max. 1 MPa
Presión recomendada en servicio:	0,1 - 0,5 MPa
Presión de prueba:	1,6 MPa
(1 MPa = 10 bar = 147 PSI)	
Temperatura del agua caliente:	max. 80 °C
Temp. recomendada del agua caliente:	65 °C
Racores excéntricos:	G ³ / ₄
Racores excéntricos:	a la derecha frío - a la izquierda caliente
Caudal con 0,3 MPa	
Monomando ducha:	32 l/min
Termostato:	43 l/min
Termostato con llave de paso:	26 l/min
Termostato con llave de paso y distribuidor:	26 l/min
Termostato Highflow:	58 l/min
iControl:	30 l/min
Monomando baño/ducha:	31 l/min // 24 l/min
Monomando baño ducha con válvula anti-retorno:	25 l/min // 24 l/min





X

Centro de la bañera / Centro la plato de ducha



Llave de paso

Y

Medida Y = Desde el centro del racor de empalme hasta el centro de la boca de entrada a la bañera dividido por 2 (si fuera necesario, adaptar a la trama de los azulejos).



Quattro válvula de 4 vías

Quattro

Agua caliente



Trio llave de paso y distribuidor

Trio

Agua fría



Mínimo • para el correcto funcionamiento.



Caño de bañera



En este sector es necesario un refuerzo del muro.



La salida que no se utiliza debe ser tapada. (DN 20 3/4")



Sólo una función posible, no dos funciones al mismo tiempo.



El caudal de desagüe debe ser como mínimo de 50 l/min

> 50 l/min

Tubería hacia las duchas laterales con pendiente.



Desagüe

Raindrain



Carcasa para purgar #15956000, no incluido en el suministro



iBox universal en combinación con Exafill, vaciador automático con chorro incorporado y rebosadero (ver página 66)

Exafill





Ruwbouw

Het symmetrische basisgarnituur iBox universeel is zowel horizontaal als verticaal toe te passen. Uitgezonderd bij montage van een badmengkraan met zekerheidscombinatie, deze kan alleen verticaal worden ingebouwd. Bij een defect functiegedeelte kan mogelijk water uit de iBox weglopen. Daarom moet de iBox boven het bad gemonteerd worden. Het lekwater wordt dan in het bad afgevoerd!

De iBox is zowel geschikt voor installatie bij het bad als bij de douche. Bij de ééngreeps badmengkraan / thermostaat met stop- en omstelkraan heeft de onderste uitgang voorrang. Indien slechts één uitgang vereist is, kan naar keuze de bovenste of de onderste uitgang aangesloten worden. De niet-vereiste uitgang moet met een stop worden afgesloten.

Grote drukverschillen tussen de koud- en warmwatertoevoer dienen vermeden te worden.

Basisgarnituur zo inbouwen, dat de aansluiting voor warm water links en voor koud water rechts zit.

Inbouwdiepte 80 mm tot 108 mm.

Verlengstuk 25 mm: #13595000

verlengset 22 mm (bij geringe inbouwdiepte):
#13593000 / #13596XXX / #13597XXX /
#15597000 / #19427000 / #97407XXX /
#98860000 / #13601000

Het basisgarnituur kan overeenkomstig de situatie ter plaatse worden ingebouwd. Montagevoorbeelden zie pag. 62 en 63.

A Installatie voor de wand.

B Installatie voor de wand.

C Montage op houdersysteem.

D Installatie in prefab systemen.

E Installatie in de wand.

F Installatie met montageset #96615000

Installatievoorbeelden met massagegegevens en capaciteitsdimensionering staan op pagina 68. De toelichting bij de gebruikte symbolen op pagina 67.

De in de handleiding aangegeven montagegematen richten zich op personen van ca. 1800 mm groot en moeten indien nodig aangepast worden. Daarbij moet in acht genomen worden dat bij een gewijzigde montagehoogte ook de minimumhoogte verandert en dat de aansluitmaten overeenkomstig moeten worden aangepast. De verbruikswaarden werden in overeenstemming met de praktijk met de bijbehorende armaturen (thermostaat/mengkraan/inbouwventiel) gemeten.

Montagetip

Om aansluitingen in te draaien de iBox door middel van een koppeling in de bankschroef vastzetten.

Spoulen

De complete installatie overeenkomstig DIN 1988/ EN 1717 spoulen. De pijlen op het spoelblok geven aan welke ingang met welke uitgang verbonden is, bijv. koud water met uitgang 1 en warm water met uitgang 2. Wanneer slechts 1 uitgang wordt gebruikt, moet men na de eerste spoeling het spoelblok 90° draaien.

iBox in combinatie met Exafill badvul-, afvoer- en overloopgarnituur (zie blz. 66)

Technische gegevens

Werkdruk: max.	max. 1 MPa
Aanbevolen werkdruk:	0,1 - 0,5 MPa
Getest bij:	1,6 MPa
(1 MPa = 10 bar = 147 PSI)	
Temperatuur warm water:	max. 80°C
Aanbevolen warm water temp.:	65°C
Aansluitmaten:	G ³ / ₄
Aansluitingen:	koud rechts - warm links
Vrije doorstroom bij 0,3 MPa:	
Douchemengkraan:	32 l/min
Thermostaat:	43 l/min
Thermostaat met stopkraan:	26 l/min
Thermostaat met stop- en omstelkraan:	26 l/min
Thermostaat Highflow:	58 l/min
iControl:	30 l/min
Badmengkraan:	31 l/min // 24 l/min
Badmengkraan met geïntegreerde zekerheidscombinatie:	25 l/min // 24 l/min



Montage zie blz. 89



X

Midden bad / Midden Douchebak



Inbouwstopkraan

Y

Maat Y = afstand tussen muuraansluitbocht en baduitloop hart op hart, gedeeld door 2 (eventueel rekening houden met de wandtegels).



Quattro 4-weg omstelkraan

Quattro



Warm water



Trio stop- en omstelkraan



Koud water

Trio



Vanaf • is het functioneren gegarandeerd.



Baduitloop



In dit bereik is een wandversterking noodzakelijk.



De niet benodigde uitgang moet met een blindstop worden afgedicht. (DN 20 3/4")



Slechts 1 functie mogelijk: geen 2 functies tegelijkertijd.



De afvoercapaciteit moet meer dan 50 l/min bedragen.

> 50 l/min



Waterleidingen voor zijdouches aflopend plaatsen.



Afvoer

Raindrain



spoelblok kompl. #15956000, behoort niet tot het leveringspakket



iBox in combinatie met Exafill badvul-, afvoer- en overloopgarnituur (zie blz. 66)

Exafill



Montage zie blz. 89



Råmontage

iBoxens grundkrop er universel - den kan monteres horisontalt og vertikalt. Der er dog en undtagelse ved montering af kar-/brusearmaturer med integreret sikkerhedskombination. Her er kun vertikal montering mulig. Da der ved evt. defekt vil komme vand i iBoxen, skal den monteres over karret, så vandet ledes ned i karret.

iBoxen er egnet til såvel kar- som bruseinstallation. Ved 1-grebs kararmatur / termostat med afspærringsventil og omskifter er den nederste afgang den primære afgang. Kræves der kun én afgang, kan den øverste eller den nederste afgang anvendes. Den afgang, der ikke er brug for, skal lukkes med en prop.

Større trykforskelle mellem koldt og varmt vand bør udjævnes.

Grundkroppen indbygges således, at varmtvandstilslutningen er til venstre og koldt vandstilslutningen er til højre.

Monteringsdybde 80 mm til 108 mm.

Forlængersæt 25 mm: #13595000

Forlænger 22 mm (ved for stor indbygningsdybde):

#13593000 / #13596XXX / #13597XXX /

#15597000 / #19427000 / #97407XXX /

#98860000 / #13601000

For monteringsseksempler se s. 62 og 63.

A Installation på væggen.

B Installation på væggen. Her med fleksibel afstandsholder med 10 mm justerbar monteringskrue.

C Montering på skinnesystemet.

D Installation på montageplade.

E Installation direkte i væggen.

F Installation med monterings-skinnesæt #96615000

Installationseksempler med mål og ledningsdimensioner kan findes fra side 68. Forklaringer til symbolerne findes på side 67.

Målene i monteringsanvisningen er ideal til personer med en størrelse på 1800 mm og skal i givet fald tilpasses. Herved skal der tages hensyn til, at den mindste højde i tilfælde af en ændret monteringshøjde ændres og at der skal tages hensyn til de ændrede tilslutningsmål. Værdierne for forbruget blev målt praksisorienteret og med de tilsvarende armaturer (termostat/blander/indbygget ventil).

Monterings-tips

For montering af tilslutningsvinkler, kan iBoxen fastspændes i en skruevinge ved hjælp af et rørstyrkke.

Gennemskylning

Den komplette installation skal gennemskyllles efter DIN 1988 / EN 1717. Pilene på tegningen viser, hvilke tilgange og afgange der er forbundet med hinanden, f.eks. koldt-vand med afgang 1 og varmt-vand med afgang 2. I tilfælde hvor kun én afgang benyttes, skal skylleblokken drejes 90° efter første gennemskylning.

iBox i kombination med Exafill påfyldnings- og overløbsgarniture (se s. 66)

Tekniske data

Driftstryk:	max. 1 MPa
Anbefalet driftstryk:	0,1 - 0,5 MPa
Prøvetryk:	1,6 MPa
(1 MPa = 10 bar = 147 PSI)	
Varmtvandstemperatur:	max. 80 °C
Anbefalet varmtvandstemperatur:	65 °C
Tilslutningsmål:	G ^{3/4}
Tilslutninger:	Koldt højre - varmt venstre
Fri gennemstrømning ved 0,3 MPa:	
Brusearmaturer:	32 l/min
Termostat:	43 l/min
Termostat med afspærringsventil:	26 l/min
Termostat med afspærringsventil og omskifter:	26 l/min
Termostat Highflow:	58 l/min
iControl:	30 l/min
Kararmaturer:	31 l/min // 24 l/min
Kararmatur med integreret sikkerhedskombination.:	25 l/min // 24 l/min





X

Midt badekar / Midt brusekar



Afspæringsventil

Y

Mål Y = Midt slangeudtag til midt kartud divideret med 2 (evt. tilpas med fugerne i fliserne).



Quattro 4-vejs ventil

Quattro



Varmt vand



Trio afspæringsventil og omskifter



Kold vand

Trio



Fra • er funktionen anvendelig.



Kartud



I dette område er en forstærkning af væggen nødvendigt.



Afgangen, der ikke benyttes, skal afpropes. (DN 20 ¾")



Det er kun muligt at benytte én funktion ad gangen.



Afløbskapaciteten skal være mere end 50 l/min.

> 50 l/min



Vandledningerne til sidebruserne med fald.



Afløb

Raindrain



Skylleblok kpl. #15956000, ikke med i leveringsomfang



iBox i kombination med Exafill påfyldnings- og overløbsgarniture (se s. 66)

Exafill





Instalação embutida na parede

O corpo de rotação simétrica pode ser instalado quer na horizontal quer na vertical. A única exceção é ao instalar uma misturadora de banheira/chuveiro com combinação de segurança. Neste caso, apenas é possível uma instalação vertical. Instalar a iBox sempre sobre a banheira. No caso de haver algum defeito nas peças da iBox a água pode fluir para lá.

A iBox é aplicável numa instalação de banheira e de chuveiro. Na misturadora de monobloco para banheira / misturadora termostática com inversor/válvula de corte, a saída inferior é prioritária. Se for apenas necessária uma saída, é possível conectar a saída superior ou inferior. A saída que não é necessária deve ser vedada com um tampão.

Grandes diferenças entre as pressões das águas quente e fria devem ser compensadas.

Instalar o corpo com a ligação para água quente à esquerda e a ligação para a água fria à direita.

Profundidade de montagem 80 mm até 108 mm.

Crescente 25 mm: #13595000

Crescente 22 mm (quando instalado demasiado longe da parede): #13593000 / #13596XXX / #13597XXX / #15597000 / #19427000 / #97407XXX / #98860000 / #13601000

O corpo pode, dependendo da construção, ser instalado de diferentes maneiras, ver nas páginas 62 e 63 exemplos de instalação

A Instalação sobre a parede.

B Instalação sobre a parede com calça ajustáveis de 10 mm.

C Montagem no sistema de suporte.

D Instalação em paredes ocas.

E Instalação em paredes de tijolo.

F Instalação com set de fixação #96615000

Exemplos de instalação com indicações dimensionais e dimensionamento das tubagens, podem ser encontrados a partir da página 68. A explicação dos símbolos empregues, encontra-se na página 67.

As dimensões de montagem indicadas nas instruções de montagem são ideais para pessoas com uma altura aprox. 1800 mm e têm que ser eventualmente adaptadas. Neste contexto deve ter-se em atenção que alterações na altura de montagem obrigam a alterações na altura mínima, bem como alterações nas dimensões de ligação. Os valores de consumo foram medidos em condições reais com o respetivo equipamento (termostato/misturadora/válvula embutida).

Conselho para montagem

Para instalar as curvas de ligação na iBox coloque um tubo na iBox e prenda-o num torno.

Purgar as tubagens

Para completar a instalação purgar as tubagens da água quente e da água fria. As setas no corpo de descarga estão a mostrar que entrada está ligada com que saída, por exemplo, água fria com saída 1 e água quente com saída 2. Se apenas estiver em uso uma saída, após a 1ª purgação o corpo de descarga deve ser rodado cerca de 90°.

iBox em combinação com Exafill com bica e avisador (ver página 66)

Dados Técnicos

Pressão de funcionamento:	max. 1 MPa
Pressão de func. recomendada:	0,1 - 0,5 MPa
Pressão testada:	1,6 MPa
(1 MPa = 10 bar = 147 PSI)	
Temperatura da água quente:	max. 80 °C
Temp. água quente recomendada:	65 °C
Distância entre eixos:	G ^{3/4}
Ligações:	fria à direita - quente à esquerda
Caudal a 0,3 MPa:	
Misturadora de chuveiro:	32 l/min
Misturadora termostática:	43 l/min
Misturadora termostática com válvula de corte:	26 l/min
Misturadora termostática com inversor/	
válvula de corte:	26 l/min
Misturadora termostática Highflow:	58 l/min
iControl:	30 l/min
Misturadora de banheira/chuveiro:	31 l/min // 24 l/min
Misturadora de banheira/duche com combinação de	
segurança integrada:	25 l/min // 24 l/min





X

Meio da banheira / Meio da base de duche



Torneira de passagem

Y

Medida Y=Centro da curva de ligação até ao centro da bica da banheira dividido por 2 (conjugado com os azulejos, se for o caso).



Quattro

Quatro válvula de diversão de 4 vias



Água quente



Trio universal inversor/válvula de corte



Água fria

Trio



• A partir deste ponto inicia-se o funcionamento correcto.



Entrada de banheira



Nesta zona é necessário um reforço na parede.



Tamponar a saída não utilizada. (DN 20 3/4")



Apenas uma saída de cada vez, não duas simultaneamente.



Capacidade de escoamento tem que ser superior a 50 l/min.

> 50 l/min



Instalar os tubos para os chuveiros laterais com ligeira inclinação.



Escoamento

Raindrain



Corpo de descarga compl. #15956000, não incluído no volume de fornecimento



Exafill

iBox em combinação com Exafill com bica e avisador (ver página (ver página 66))





Montaż przyłączy

Uniwersalny okrągły kształt korpusu iBox pozwala na dowolny sposób montażu i zabudowy, zarówno pionowy jak i poziomy. Z wyjątkiem montażu armatury wannowej ze zintegrowanym systemem zabezpieczającym do wylewki, możliwy jest tylko montaż pionowy. W przypadku uszkodzenia jakichkolwiek elementów przepływająca woda może kapać z iBoxa, dlatego też należy zamontować go nad wanną, dzięki czemu woda będzie mogła spływać do wanny.

iBox można wykorzystać zarówno jako baterię wannową jak i jako baterię natryskową. Przy jednouchwytowym mieszaczu wannowym / termostat z zaworem odcinającym-przełączającym dolne wyjście ma pierwszeństwo. Jeżeli konieczne jest tylko jedno wyjście, to można podłączyć do wyboru górne lub dolne wyjście. Niewykorzystane wyjście należy zamknąć korkiem uszczelniającym.

Znaczne różnice ciśnień na dopływach ciepłej i zimnej wody muszą zostać wyrównane.

Korpus zabudować w taki sposób, aby przyłącza zimnej wody znajdowały się po prawej stronie, a ciepłej po lewej.

Głębokość montażu 80 - 108 mm

Przedłużka 25 mm: #13595000

Rozeta maskująca 22 mm (przy małej głębokości zabudowy): #13593000 / #13596XXX / #13597XXX / #15597000 / #19427000 / #97407XXX / #98860000 / #13601000

Korpus może zostać zabudowany w różnych stadiach budowlanych, przykłady montażowe patrz str.62 i 63.

- A** Instalacja na ścianie.
- B** Instalacja przed ścianą. Na śrubach gwintowanych M10 jako elementy dystansowe.
- C** Montaż na systemie staży.
- D** Instalacja gotowych płyt montażowych albo gotowych kabin.
- E** Instalacja w ścianie.
- F** Instalacja z szynami mocującymi #96615000

Przykłady instalacji z podaniem ciężarów i rozmiarów przewodów, patrz od strony 68. Wyjaśnienie używanych symboli, patrz strona 67.

Wymiary montażowe podane w instrukcji montażowej są idealne dla osób o wzroście sięgającym ok. 1800 mm i w razie konieczności należy je dostosować. Należy przy tym zwrócić uwagę na fakt, iż przy zmienionej wysokości montażu zmienia się minimalna wysokość, a także ulegają zmianie wymiary przyłączy. Wartości zużycia zostały zmierzone w praktyczny sposób za pomocą przynależnej armatury (termostat/mieszalnik/zawór podtynkowy).

Wskazówki montażowe

Aby dokręcić przyłącza, zamocować iBox w imadle.

Plukanie

Przeplukać gotową instalację zgodnie z normą. Zaznaczyć strzałką jakie doprowadzenie instalacji odpowiada kolejnemu przyłączu np. zimna woda z odpływem 1, ciepła woda z odpływem 2. W przypadku gdy wykorzystywane jest tylko jedno wyjście, należy obrócić po pierwszym przepłukaniu o 90° przepłukiwany blok.

iBox w kombinacji z odpływem wannowym Exafill posiadającym możliwość napełniania i opróżniania wanny (patrz strona 66)

Dane techniczne

Ciśnienie robocze:	maks. 1 MPa
Zalecane ciśnienie robocze:	0,1 - 0,5 MPa
Ciśnienie próbne:	1,6 MPa
(1 MPa = 10 bary = 147 PSI)	
Temperatura wody gorącej:	maks. 80 °C
Zalecana temperatura wody gorącej:	65 °C
Wymiary przyłącza:	G ^{3/4}
Przyłącza:	Zimna z prawej - Ciepła z lewej
Swobodny przepływ przy 0,3 MPa:	
Mieszacz prysznicowy:	32 l/min
Termostat:	43 l/min
Termostat z zaworem odcinającym:	26 l/min
Termostat z zaworem odcinającym-przełączającym:	26 l/min
Termostat Highflow:	58 l/min
iControl:	30 l/min
Mieszacz wannowy:	31 l/min // 24 l/min
Mieszacz wannowy ze zintegrowanym systemem zabezpieczającym do wylewki:	25 l/min // 24 l/min





X

Środek wanny / Środek brodzika



Zawór podtynkowy

Y

Wymiar Y = środek mocowania węża prysznicowego do środka wylewki napełniającej wannę podzielony przez 2 (ewentualnie dopasować do układu płytek ceramicznych).



Regulator czterodrożny Quattro

Quattro



Ciepła woda



Zawór odcinający i regulacyjny Trio Universal



Zimna woda

Trio



Od • możliwe jest funkcjonowanie.



Wylewka wannowa



W tym obszarze konieczne jest wzmocnienie ściany.



Nie wykorzystany wylot należy zakorkować dołożonym w dostawie korkiem. (DN 20 3/4")



Możliwe uruchamianie tylko każdego odbiornika osobno.



Wydajność odpływu musi być wyższa niż 50 l/min.

> 50 l/min



Przewody doprowadzające do pryszniców bocznych położyć z nachyleniem.



Odpływ

Raindrain



Blok płuczący #15956000, Nie jest częścią dostawy



iBox w kombinacji z odpływem wannowym Exafill posiadającym możliwość napełniania i opróżniania wanny (patrz strona 66)

Exafill





Hrubá montáž

Rotačně symetrické základní těleso iBoxu je univerzálně použitelné, horizontálně jakož i vertikálně. Neplatí pro montáž vanové armatury s bezpečnostní kombinací, zde je možná pouze vertikální montáž. Protože v případě závady funkčních dílů může začít z jednotky iBox vytékat voda, musí být iBox instalován nad vanou, která vytékající vodu odvede.

iBox je vhodný jak pro vanovou, tak i pro sprchovou instalaci. U vanové / termostat s uzavíracím a přepínacím ventilem jednoruční pákové baterie je prioritní spodní vývod. Pokud je potřeba pouze jeden vývod, je možné si zvolit horní nebo dolní vývod. Nepoužitý vývod musí být utěsněn zaslepovací zátkou.

Je nutné vyrovnat velké rozdíly tlaku mezi přípoji studené a teplé vody.

Základní těleso zabudovat tak, aby se přípoj teplé vody nacházel vlevo a přípoj studené vody vpravo.

Hloubka zabudování 80 mm až 108 mm.

prodloužení 25 mm: #13595000

prodloužení 22 mm (při malé hloubce zabudování):

#13593000 / #13596XXX / #13597XXX /

#15597000 / #19427000 / #97407XXX /

#98860000 / #13601000

Základní těleso může být namontováno v souladu s podmínkami na stavbě, příklady montáže viz strana 62 a 63.

A Instalace na stěnu.

B Instalace před stěnu. Zde s variabilními rozpěrkami pomocí šroubů M 10.

C Montáž na nosný systém.

D Instalace na montážní panely nebo prefabrikované buňky.

E Instalace přímo do stěny.

F Instalace se sadou montážních lišt #96615000

Příklady instalace s údaji o rozměrech a dimenzování potrubí jsou uvedeny od strany 68. Vysvětlivky k použitým symbolům naleznete na straně 67.

Montážní rozměry uvedené v návodu pro montáž jsou ideální pro osoby s výškou postavy přibližně 1800 mm a v případě potřeby je nutné je přizpůsobit. Při tom je zapotřebí dbát nato, že se při změně výšky montáže změni požadovaná minimální výška a že je třeba brát ohled na přípojovací rozměry. Spotřební hodnoty byly v praxi měřeny na příslušných armaturách (termostat/baterie/podomítkový ventil).

Montážní tip

Aby bylo možno zatočit přípojovací tvarovky do iBoxu, upněte iBox pomocí části trubky do svěráku.

Propláchnutí

Kompletní instalaci propláchnout podle normy DIN 1988. Šipka na proplachovacím bloku ukazuje, který přívod je spojen se kterým vedením vývodu, např. studená voda s vývodem 1 a teplá voda s vývodem 2. Je-li potřebný pouze jeden vývod, musí být po prvním vypláchnutí proplachovací blok otočen o 90 stupňů.

iBox v kombinaci s vanovým napouštěním Exafill s odpadní a přepadovou garniturou (viz strana 66)

Technické údaje

Provozní tlak:	max. 1 MPa
Doporučený provozní tlak:	0,1 - 0,5 MPa
Zkušební tlak:	1,6 MPa
(1 MPa = 10 bar = 147 PSI)	
Teplota horké vody:	max. 80 °C
Doporučená teplota horké vody:	65 °C
Rozteč připojení:	G ³ / ₄
Přípoje:	studená vpravo - teplá vlevo
Volný průtok při 0,3 MPa	
Sprchová armatura:	32 l/min
Termostat:	43 l/min
Termostat s uzavíracím ventilem:	26 l/min
Termostat s uzavíracím a přepínacím ventilem:	26 l/min
Termostat Highflow:	58 l/min
iControl:	30 l/min
vanová baterie:	31 l/min // 24 l/min
Vanová baterie s integrovanou bezpečnostní kombinací:	25 l/min // 24 l/min





X

Střed koupací vany / Střed sprchové vany



Podomítkový uzavírací ventil

Y

Rozměr Y = vzdálenost středu připojení sprchové hadice od středu vanového napouštění dělitelná 2 (eventuelně přizpůsobit rozměru obkladů).



Quattro

Quattro čtyřcestné přestavování



Teplá voda



Trio Universal - Uzavírací a přepínací ventil



Studená voda

Trio



Od • je zaručená funkce



Vanový vtok



V této oblasti je potřebné zesílení stěny.



Nepoužitý vývod musí být utěsněn zaslepovací zátkou. (DN 20 3/4")



Je možné použít pouze jeden spotřebič, ne dva současně.



Odtokový výkon musí být vyšší než 50 l/min.

> 50 l/min



Vodovodní potrubí pro boční sprchy nainstalovat se spádem.



Odtok

Raindrain



výplachový blok kompl. #15956000, není součástí dodávky



Exafill

iBox v kombinaci s vanovým napouštěním Exafill s odpadní a přepadovou garniturou (viz strana 66)





Hrubá montáž

Rotačne symetrické základné teleso iBoxu je univerzálne použité, horizontálne aj vertikálne. Neplatí pro montáž vanové armatury s bezpečnostní kombinací, zde je možná pouze vertikální montáž. Pretože v prípade poruchy funkčných častí môže začať z jednotky iBox vytekať voda, musí byť iBox namontovaný nad vaňou, ktorá vytekajúcu vodu odvedie.

iBox je vhodný nielen pre vaňovú, ale aj pre sprchovú inštaláciu. Pri jednoručnej pákovej vaňovej batérii / termostate s uzatváracím a prestavovacím ventilom je prioritný spodný vývod. Ak sa vyžaduje iba jeden vývod, je možné voliteľne pripojiť horný alebo dolný vývod. Nepoužitý vývod sa musí utesniť zátkou.

Veľké rozdiely v tlaku medzi prípojkami studenej a teplej vody musia byť vyrovnané.

Základné teleso zabudovať tak, aby prívod teplej vody bol vľavo a prívod studenej vody vpravo.

Montážna hĺbka: 80 mm až 108 mm.

Predĺženie 25 mm: #13595000

Predĺženie 22 mm (pri malej montážnej hĺbke):

#13593000 / #13596XXX / #13597XXX /

#15597000 / #19427000 / #97407XXX /

#98860000 / #13601000

Základné teleso je montované podľa podmienok na stavbe podľa príkladov inštalácie vii strana 62 a 63.

A Inštalácia na stenu.

B Inštalácia pred stenu pomocou nastaviteľných 10 mm skrutiek.

C Montáž na nosný systém.

D Inštalácia na montážne dosky hotového domu alebo hotové bunky.

E Inštalácia priamo do steny.

F Inštalácia so sadou montážnych líšt #96615000

Inštaláčne príklady s uvedením rozmerov a výkonov nájdete od strany 68. Vysvetlenie použitých symbolov nájdete na strane 67.

Montážne rozmery uvedené v návode na montáž sú ideálne pre osoby s výškou postavy približne 1800 mm a v prípade potreby je nutné ich prispôsobiť. Pritom je nutné si uvedomiť, že pri zmenenej výške montáže sa mení minimálna výška a a je nutné dbať na rozmery rozmiestnenia prípojk. Hodnoty spotreby boli merané blízko praxe s príslušnými armatúrami (termostat/zmiešavacia batéria/ventil pod omietku).

Montážny tip

Aby sa dali pripojovacie kusy dobre zatočiť, upne sa iBox pomocou trubkovej tvarovky do zveráku.

Prepláchnutie

Kompletnú inštaláciu prepláchnuť podľa normy DIN 1988. Šípka na preplachovacom bloku ukazuje, ktorý prívod je spojený s ktorým vedením vývodu, napr. prívod studenej vody s vývodom 1, prívod teplej vody s vývodom 2. Ak je použitý len jeden vývod, musí byť po prvom prepláchnutí preplachovací blok otočený o 90 stupňov.

iBox kombinovaný s EXAFILL vaňovým napúšťaním s odpadovou a prepádovou garnitúrou (viď strana 66)

Technické údaje

Prevádzkový tlak:	max. 1 MPa
Doporučený prevádzkový tlak:	0,1 - 0,5 MPa
Skúšobný tlak:	1,6 MPa
(1 MPa = 10 bar = 147 PSI)	
Teplota teplej vody:	max. 80 °C
Doporučená teplota teplej vody:	65 °C
Prípájacie rozmery:	G ^{3/4}
Prípoje:	studená vpravo - teplá vľavo
Volný prietok pri 0,3 MPa	
Sprchová batéria:	32 l/min
Termostatická batéria:	43 l/min
Termostatická batéria s uzatváracím ventilom:	26 l/min
Termostatická batéria s uzatváracou jednotkou a prestavovacím ventilom:	26 l/min
Termostatická batéria Highflow:	58 l/min
iControl:	30 l/min
vaňová batéria:	31 l/min // 24 l/min
mešalna baterija za kopalno kad	
z vgrajeno varovalno kombinacijo:	25 l/min // 24 l/min





X

Stred vane / Stred sprchovej vane



Podmietský uzatvárací ventil

Y

Rozmer Y = vzdialenosť stredu pripojenia sprchovej hadice od stredu vaňového napúšťania deliteľná 2 (prípadne prispôsobíť rozmeru obkladu)



Quattro štvorcestné prestavenie



Teplá voda



Trio univerzálny uzatvárací a prestavovací ventil



Studená voda

Trio



Od • je zaručená funkcia.



Vaňový vtok



V tejto oblasti je potrebné zosilnenie steny.



Nepoužitý vývod musí byť zaslepený zátkou. (DN 20 3/4")



Je možné používať len jeden spotrebič, nie oba súčasne.



Výkon odtoku musí byť vyšší ako 50 l/min.

> 50 l/min



Vodovodné potrubie pre bočné sprchy vypádovať.



Odtok

Raindrain



Kompletný vyplachovací blok #15956000, nie je súčasťou dodávky



iBox kombinovaný s EXAFILL vaňovým napúšťaním s odpadovou a prepádovou garnitúrou (viď strana 66)

Exafill





粗安装

iBox的旋转对称基体可以作为万能部件使用，在此只能垂直安装。始终在浴缸上面安装iBox。如果iBox零件即将断裂，水可能从这里流出！

iBox 用于安装面盆和花洒。对于带闭锁阀和切换阀的面盆手持龙头/恒温龙头，优先使用下出水口。如果仅需一个出水口，那么可以连接上出水或下出水。但另一个出水口必须用塞子封住。

冷热水管间过大的压力差必须予以平衡。

基体安装在热水连接装置左侧和冷水连接装置右侧。

安装深度：80 mm至108 mm。

加长 25 mm: #13595000

加长件22mm（墙壁不够深时）：#13593000 / #13596XXX / #13597XXX / #15597000 / #19427000 / #97407XXX / #98860000 / #13601000

根据构造的实际情况安装基体，安装范例参见第62页和第63页。

A 直接墙面安装。

B 直接墙面安装，带10 mm可调节的固定柱头螺栓。

C 安装在支柱上。

D 中空墙壁安装

E 砖墙安装

F 使用固定组件安装 #96615000

带数据和管道尺寸的安装实例请从 68 页起查找。所使用符号的说明参见 67 页。

本安装说明中所规定的安装尺寸理想用于身高1800 mm左右的人士。尺寸可根据需要进行修改。在这种情况下，您必须留意，如果安装高度改变，则花洒到地板的最小高度也随之改变，且必须考虑到连接尺寸的改变。已根据实际情况测量相关龙头（恒温器/冷热水龙头/反水阀）的消耗值。

安装提示

iBox通过管件在台虎钳内处理，这样可以旋入连接件。

冲洗管系统

按照德国工业标准1988/欧洲标准1717清洁全部安装件。箭头指示清洗端，该流向与该出口导通装置连接，例如：冷水与出口1连接，热水与出口2连接。如果只需要一个出口，那么，在第一个清洁过程后，90°旋转冲洗端。

iBox与下水部件组合，配备出水组件及溢流组件（参见第页 66）

技术参数

工作压强:	最大 1 MPa
推荐工作压强:	0,1 – 0,5 MPa
测试压强:	1,6 MPa
(1 MPa = 10 bar = 147 PSI)	
热水温度:	最大 80°C
推荐热水温度:	65°C
中心距离:	G
连接管线:	左热右冷
0,3 MPa时的流速:	
淋浴龙头:	32 升/分钟
恒温龙头:	43 升/分钟
恒温龙头及闭锁单元:	26 升/分钟
恒温龙头及闭锁和分流器单元:	26 升/分钟
恒温龙头 Highflow:	58 升/分钟
iControl:	30 升/分钟
浴缸—淋浴龙头:	31 升/分钟 // 24 升/分钟
浴缸淋浴龙头及整体式安	
全组合:	25 升/分钟 // 24 升/分钟



安装 参见第页 89



X

槽中间 / 中心淋浴盆



截止阀

Y

尺寸Y = 软管壁出口弯管的中心至浴盆加水口中心除以2 (匹配瓷砖布置)。



Quattro 四通转换器

Quattro



热水



通用的三通截止阀和换向阀



冷水

Trio



从开始, 正常功能得以保证。



浴缸出水口



该区域需要一个加固边壁。



插入不使用的插座。(DN 20 ")



只有一项功能。



排水功率必须大于 50 l/min。

> 50 l/min



安装水管, 用于带有梯度的淋浴器。



排水口

Raindrain



全套清洗端 #15956000, 不在供货范围内



iBox与下水部件组合, 配备出水组件及溢流组件 (参见第页 66)

Exafill



安装 参见第页 89



предварительный монтаж

Вращательно-симметричный корпус iVox может использоваться универсально, как горизонтально, так и вертикально. Кроме монтажа арматуры ванны с комбинированным предохранителем здесь возможна только вертикальная установка. Поскольку при неисправности функциональных деталей у iVox может выходить вода, iVox необходимо монтировать над ванной, чтобы выступающая вода могла стекать в ванну! iVoxпредназначен для монтажа как ванн, так и душей. Для однорычажного смесителя для ванны / термостата с запорным и регулировочным клапаном преимущество имеет нижний отвод. Если нужен только один отвод, можно по выбору подключить верхний или нижний отвод. Неиспользуемый отвод нужно закрыть крышкой.

донного клапа. Перед установкой смесителя необходимо регулировочными кранами выровнять авление холодной и горячей воды при помощи вентилей регулирующих подачу воды в квартиру.

Установите корпус так, чтобы подключение горячей воды находилось слева, а холодной – справа.

Глубина установки от 80 до 108 мм.

Удлинение 25 мм: #13595000

Удлинение 22 мм (при малой глубине установки):
#13593000 / #13596XXX / #13597XXX /
#15597000 / #19427000 / #97407XXX /
#98860000 / #13601000

Корпус может монтироваться, согласно условиям строительства, примеры монтажа см. на стр. 62 и 63.

A варианты установки

B Установка на стене. Здесь с гибким распорным держателем, благодаря винтам 10.

C Монтаж на системе стоек.

D Установка на монтажных плитах сборных домов или блоках сборных домов.

E монтаж в кирпичную стену

F Установка с помощью комплекта монтажных шин #96615000

Примеры монтажа с указанием размеров и размеры трубопровода см. на стр. 68. Пояснение к используемым символам см. на стр. 67.

Указанные в монтажной инструкции монтажные размеры идеальны для лиц ростом около 1800 мм. В случае необходимости монтажные размеры следует менять. При этом нужно учесть, что при изменившейся высоте монтажа меняется также и минимальная высота, а изменение установочных размеров нужно принять во внимание. Расход измерен практически с помощью соответствующей арматуры (термостат/смеситель/скрытый клапан).

Подсказка по монтажу

Для завинчивания фитингов закрепите iVox с помощью куска трубы в тисках.

Промывка

Промывайте все установленное оборудование, согласно DIN 1988 / EN 1717. Стрелки на промывочном блоке показывают, какой вход связан с отводом. напр., холодная вода с отводом 1, а горячая вода - с отводом 2. Если требуется только один отвод, после первой промывки промывочный блок необходимо повернуть на 90°.

iVox в комбинации со впуском ванны Ehafill со сливной и переливной гарнитурой (см. стр. 66)

Технические данные

Рабочее давление:	не более. 1 МПа
Рекомендуемое рабочее давление:	0,1 - 0,5 МПа
Давления:	1,6 МПа
(1 МПа = 10 bar = 147 PSI)	
Температура горячей воды:	не более. 80 °C
Рекомендуемая темп. гор. воды:	65 °C
Размеры подключения:	G ^{3/4}
Подключение:	холодная справа - горячая слева
Свободное истечение при 0,3 МПа:	
Смеситель душа:	32 л/мин
Термостат:	43 л/мин
Термостат с запорным вентилем:	26 л/мин
Термостат с запорным и переключающим вентилем:	26 л/мин
Термостат Highflow:	58 л/мин
iControl:	30 л/мин
Смеситель ванны:	31 л/мин // 24 л/мин
Смеситель ванны со встроенным комбинированным предохранителем:	25 л/мин // 24 л/мин







X середина ванны / Середина душевой ванны  Скрытый вентиль

Y Размер Y = середина дуги подключения шланга, деленная на 2 (или подогнать пор растр плитки).  Четырехходовой переключатель Quattro

 Теплая вода

 Холодная вода

 Гарантированное функционирование при показателях выше • .

 В этой области требуется укрепление стены.

 Возможно использование только одного потребителя, не двух одновременно.

 Водопроводы для боковых душей прокладывают под наклоном .

 промывочный блок кпл. #15956000, не включено в объем поставки!

 Трехходовой запорный и переключающий вентиль Trio Universal

Trio  Водозабор

 Ненужный выход необходимо уплотнить с помощью заглушки. (DN 20 3/4")

 Слив должен иметь производительность более 50 л/мин.

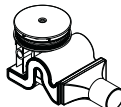
> 50 l/min  Слив

Raindrain  iBox в комбинации со впуском ванны Exafill со сливной и переливной гарнитурой (см. стр. 66)





Csőszerelés

Az iBox szimmetrikus rotációjú belső szerelékével együtt univerzálisan – vízszintesen és függőlegesen egyaránt – elhelyezhető. A biztonsági szerelvényvel ellátott kádcsaptelep kivételével, itt csak a függőleges beépítés lehetséges. Mivel a működő részek meghibásodásakor víz kerülhet az iBox-ra, ezért az iBox-ot a kád fölé kell felszerelni, hogy a kifolyó víz a kádba folyhasson!

Az iBox kádhoz és tusolóhoz egyaránt alkalmas. Egykaros kádcsaptelep / elzáró- és váltószeleppel rendelkező termosztát esetében az alsó kiállítás az elsődleges. Ha csak egy kiállásra van szükség, akkor tetszés szerint a felső vagy az alsó kiállást lehet csatlakoztatni. A használaton kívüli kiállást vakdugóval kell lezárni.

A hidegvíz- és a melegvíz-csatlakozások közötti nagy nyomáskülönbséget kikell egyenlíteni!

Az alaptestet úgy szereljük be, hogy a melegvíz csatlakozása bal oldalra, míg a hidegvíz csatlakozása jobb oldalra kerüljön.

Beépítési mélység: 80 – 108 mm

Hosszabbítás 25 mm: #13595000

Hosszabító készlet 22 mm (kis beépítési mélység esetén):
#13593000 / #13596XXX / #13597XXX /
#15597000 / #19427000 / #97407XXX /
#98860000 / #13601000

Az alaptestet az építészeti adottságoknak megfelelően szereljük be. A szerelési példákat lásd a 62. és a 63. oldalon.

A Szerelés közvetlenül a falra.

B Távtartó szerkezetre való szerelés.

C Tartórendszerre szerelés.

D Szerelés készház-szerelő-lapokra vagy kész cellákra.

E Szerelés falba süllyesztve.

F Szerelés szerelősín-szettel #96615000

Felszerelési példák méreteivel és vezeték-dimenzionálással az 68 oldaltól kezdődően találhatóak. A használt szimbólumok magyarázatai az 67 oldalon találhatóak.

A szerelési útmutatóban megadott szerelési méretek kb. 1800 mm testmagasságú személyeknek alkalmasak, és ennek megfelelően átméretezendők. Itt arra kell ügyelni, hogy az átméretezett szerelési magasságnál megváltozik a minimális magasság és figyelembe kell venni a csatlakozó méreteinek változását. A fogyasztási értékeket, a gyakorlathoz közel álló módon, a hozzátartozó csaptelepekkel (termosztát/keverő csaptelep/vakolat alatti szelep) mértük.

Szerelési ötlet

A csatlakozó közdarabok becsavarásához - egy cső segítségével - fogjuk satuba az iBox-ot.

Átöblítés

Öblítsük át a teljes szerelvényt a DIN 1988 sz. szabvány előírásainak megfelelően. Az öblítőblokkon látható nyilak mutatják, hogy melyik beömlő vezeték melyik lefolyó vezetékhez kapcsolódik, így pl. a hidegvíz vezetéke az 1. kiálláshoz és a melegvíz vezetéke a 2. kiálláshoz. Amennyiben csupán egyetlen kiállásra van szükség, az első öblítési műveletet követően forgassuk el 90°-kal az öblítő-blokkot.

iBox, valamint Exafill kádtöltő, le- és túlfolyó kombinációja (lásd a oldalon 66)

Műszaki adatok

Üzemi nyomás:	max. 1 MPa
Ajánlott üzemi nyomás:	0,1 - 0,5 MPa
Nyomáspróba:	1,6 MPa
(1 MPa = 10 bar = 147 PSI)	
Forróvíz hőmérséklet:	max. 80 °C
Forróvíz javasolt hőmérséklete:	65 °C
Csatlakozási méret:	G $\frac{3}{4}$
Csatlakozás:	hideg jobbra – meleg balra
Szabad átfolyás 0,3 MPa nyomás esetén:	
Zuhanycsaptelep:	32 l/perc
Termosztát:	43 l/perc
Termosztát elzárószeleppel:	26 l/perc
Termosztát elzáró- és váltószeleppel:	26 l/perc
Termosztát Highflow:	58 l/perc
iControl:	30 l/perc
Kádcsaptelep:	31 l/perc // 24 l/perc
Kádcsaptelep beépített biztonsági egységgel:	25 l/perc // 24 l/perc



Szerelés lásd a oldalon 89



X

A kád közepe / Zuhanytálca közepe



Falsík alatti szelep

Y

Y méret = a csőcsatlakozó közepétől a kádöntő befolyócső közepéig, osztva kettővel (szükség esetén a csempe kiosztásához igazítva).



Quattro

Quattro négy-utas átalakító



Melegvíz



Trio

Trio univerzális záró- és váltószelep



Hidegvíz



A • -től működik az adott funkció.



Kádbevezetés



Ezen a területen a fal megerősítésére van szükség.



A fölösleges kimenetet vakdugóval kell lezárni. (DN 20 ¾")



Egyidejűleg csak egy fogyasztót lehet használni, két fogyasztó (zuhanyrózsa, oldalzuhanyok) egyszerre nem tud működni.



> 50 l/min

A lefolyó teljesítményének 50l/percnél magasabbnak kell lenni



Az oldalzuhanyokhoz a vízvezeték lejtéssel ajánlott beszerezni.

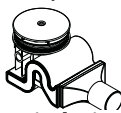

Raindrain

Lefolyó



Öblítőblokk csatlakozó #15956000, a szállítási egység nem tartalmazza



Exafill

iBox, valamint Exafill kádöntő, le- és túlfogyó kombinációja (lásd a oldalon 66)





Raaka-asennus

Pyörösymmetrinen iBox:in peruskappale on yleiskäyttöinen, sen voi asentaa sekä pysty-, että vaakasuoraan. Poikkeuksena sellaisten ammearmatuurit, joissa on varmuuskombinaatio, tällöin vain vaakasuora asennus on mahdollinen. Koska iBox:ista voi valua vettä toimintaosien vahingoittuessa, iBox on asennettava ammeen yläpuolelle, jotta valuva vesi pääsee valumaan ammeeseen!

iBox soveltuu sekä amme- että myös suihkuasennukseen. Alempi lähtö on tarkoitettu etupäässä yksikäsi ammekoittimelle / termostaatille, jossa on sulku- ja vaihtoventtiili. Jos tarvitaan vain yksi lähtö, liitännän voi tehdä valinnaisesti ylempään tai alempaan lähtöön. Käyttämättä jäänyt lähtö on tiivistettävä sulkutulpalla.

Suuret paine-erot kylmä- ja kuumavesiliitäntöjen välillä on tasattava.

Asenna peruskappale siten, että lämminvesiliitäntä tulee vasemmalle ja kylmävesiliitäntä aina oikealle puolelle.

Asennussyvyys 80 mm - 108 mm.

Pidennys 25 mm: #13595000

Pidennys 22 mm (pienemmällä asennussyvyydellä):

#13593000 / #13596XXX / #13597XXX /

#15597000 / #19427000 / #97407XXX /

#98860000 / #13601000

Peruskappaleen voi asentaa rakennuksen asettamien reunaehtojen mukaisesti, katso asennusesimerkkejä sivuilla 62 ja 63.

A Asennus seinään

B Asennus seinään. Tässä joustavaa etäisyydenpitintä käyttäen kaksikierteisillä 10 mm ruuveilla.

C Asennus kannatinjärjestelmään

D Asennus valmistalo-asennuslevyille tai valmistiloihin.

E Asennus suoraan seinään.

F Asennus käyttäen asennuskisko-sarjaa #96615000

Asennusesimerkit mittoineen ja putkitietoineen löytyvät alkaen sivulta 68. Käytettyjen merkien selitys sivulla 67.

Asennusohjeessa annetut asennusmitat sopivat n. 180 cm:n pituiselle henkilölle, ja niitä on tarvittaessa muutettava. Tässä on otettava huomioon, että asennuskorkeuden muuttuessa muuttuu myös vähimmäiskorkeus, ja muutos on otettava huomioon liitäntöjen mitoissa. Kulutusarvot on mitattu käytännönläheisesti kaikkine armatuureineen (termostaatti/sekoitin/seinäventtiili).

Asennusvihje

Kiinnitä iBox putkenpätkän avulla ruuvipenkkiin, jotta saat kierrettyä liitinkappaleet sisään.

Huuhdeltu

Koko asennettu järjestelmä on huuhdeltava DIN 1988 / EN 1717 mukaisesti. Huuhtelulohkossa olevat nuolet osoittavat mikä tulo on liitettyä mihinkin lähtöön, esim. kylmävesi lähtöön 1 ja lämminvesi lähtöön 2. Jos tarvitaan vain 1 lähtö, ensimmäisen huuhdelun jälkeen huuhdeltulohkoa on kierrettävä 90°.

iBox yhdessä Exafill ammeentäyttöhana varustettuna tyhjennys- ja ylivuoto-varusteilla (katso sivu 66)

Tekniset tiedot

Käyttöpaine:	maks. 1 MPa
Suosittelut käyttöpaine:	0,1 - 0,5 MPa
Koestuspaine:	1,6 MPa
(1 MPa = 10 bar = 147 PSI)	
Kuuman veden lämpötila:	maks. 80 °C
Kuuman veden suosituslämpötila:	65 °C
Liitäntämitat:	G ^{3/4}
Liittimet:	kylmä oikealla - kuuma vasemmalla
Vapaa läpivirtaus 0,3 MPa paineella:	
Suihkusekoittaja:	32 l/min
Termostaatti:	43 l/min
Termostaatti sulkuventtiilillä:	26 l/min
Termostaatti sulku- ja vaihtoventtiilillä:	26 l/min
Termostaatti Highflow:	58 l/min
iControl:	30 l/min
Ammesekoittaja:	31 l/min // 24 l/min
Ammesekoittaja integroidulla turvayhdistelmällä:	25 l/min // 24 l/min



Asennus katso sivu 89



X Ammeen keskusta / Suihkualtaan keskusta  Upotettava venttiili

Y Mitta Y = etäisyys letkunliitäntäkaaren keskeltä ammeen tuloaukon keskelle jaettuna kahdella (sovitus mahdollisesti laattaruukkoon).

 4-tiesäätöventtiili
Quattro

 Lämmin vesi

 Trio -sulku- ja säätöventtiili
Trio

 Kylmä vesi

 Tämä toiminta on taattuna • alkaen.

 Vedentulo ammeeseen

 Tässä kohdassa seinää on vahvistettava

 Käyttämätön lähtöliitin on suljettava sulku-
tulpalla. (DN 20 ¾")

 Vain yksi vedenkäyttöpiste kerrallaan on mahdollista, ei kahta samanaikaisesti.

 Poisvirtaustehon on oltava enemmän kuin 50l/min.
> 50 l/min

 Vie sivusuihkujen syöttöputket alaspäin laskevasti.

 Veden poisvirtaus
Raindrain

 Huuhtelulohko, täyd. #15956000, ei kuulu toimitukseen

 iBox yhdessä Exafill ammeentäyttöhana varustettuna tyhjennys- ja ylivuotovarusteilla (katso sivu 66)
Exafill





Grundmontering

Den rotationsymmetriska grundkonstruktionen hos iBox är universellt användbar, så väl horisontellt som vertikalt. Detta gäller dock inte för monteringen av kararmatur med säkerhetskombination; här är endast vertikal montering möjlig. Eftersom vatten kan tränga ut vid iBoxen om funktionsdelar är defekta så måste iBoxen monteras över karet så att det vatten som kommer ut kan rinna ner i karet!

iBox är avsedd för såväl kar- som duschinstallation. Till engreppsblandare / termostat med spärr- och omställningsventil används främst det undre avloppet. Om endast ett avlopp behövs kan antingen det övre eller undre avloppet anslutas. Det avlopp som inte behövs skall tätas med en plugg.

Stora tryckskillnader mellan anslutningarna för varmt och kallt vatten måste utjämnas.

Montera grundkonstruktionen så att varmvattensanslutningen sitter till vänster och kallvattenanslutningen till höger.

Monteringsdjup 80 mm till 108 mm.

Förlängning 25 mm: #13595000

Förlängning 22 mm (vid litet monteringsdjup):
#13593000 / #13596XXX / #13597XXX /
#15597000 / #19427000 / #97407XXX /
#98860000 / #13601000

Grundkonstruktionen monteras enligt de förutsättningar som gäller på platsen, se monteringsexempel på sidor 62 och 63.

A Vägginstallation.

B Vägginstallation. Här med flexibel avståndshållare genom skruvstift storl. 10.

C Montering på stödsystem.

D Installation på monteringsplattor till färdighus eller färdigsektioner.

E Installation direkt i väggen.

F Installation med monteringsknesenet #96615000

Du hittar installationsexempel med uppgifter om mått och ledningsdimensioner från sidan 68. Förklaringen till de använda symbolerna på sidan 67.

De monteringsmått som anges i monteringsanvisningen passar 1,80 m långa personer och måste eventuellt anpassas. Det är då viktigt att tänka på att den minsta höjden ändras när monteringshöjden blir en annan och att hänsyn måste tas till de ändrade anslutningsmåten. Förbrukningsvärdena uppmättes under användning med de tillhörande armaturerna (termostat/blandare/infälld ventil).

Monteringstips

Sätt fast iBox i skruvtvingen med hjälp av ett rör när anslutningsstycken ska skruvas in.

Spola

Spola igenom hela installationen enligt DIN 1988 / EN 1717. Pilarna på spolblocket visar vilken inkommande ledning som är ansluten till vilket avlopp, t.ex. kallvatten till avlopp 1 och varmvatten till avlopp 2. Om det bar behövs ett avlopp måste spolblocket vridas 90° efter första spolningen.

iBox i kombination med ett Exafill karinlopp med från- och överrinningsset (se sidan 66)

Tekniska data

Driftstryck:	max. 1 MPa
Rek. driftstryck:	0,1 - 0,5 MPa
Tryck vid provtryckning:	1,6 MPa
(1 MPa = 10 bar = 147 PSI)	
Varmvattentemperatur:	max. 80 °C
Rek. varmvattentemp.:	65 °C
Anslutningsmått:	G ³ / ₄
Anslutningar:	kallt höger - varmt vänster
Fri genomströmning vid 0,3 MPa:	
Duschblandare:	32 l/min
Termostat:	43 l/min
Termostat med spärrventil:	26 l/min
Termostat med spärr- och omställningsventil:	26 l/min
Termostat Highflow:	58 l/min
iControl:	30 l/min
Karblandare:	31 l/min // 24 l/min
Karblandare med integrerad säkerhetskombination:	25 l/min // 24 l/min





X

Mitt på badkar / Mitten av duschkaret



Invändig ventil

Y

Mått Y = mitten av slanganslutningskrök till mitten av karinlopp delat med två (anpassa eventuellt till kakelmönstret).



Quattro

Quattro Fyrvägsomkastare



Varmvatten



Trio Universell avstängningsventil och omkastare



Kallvatten

Trio



Från • garanteras funktionen.



Badkarskran



Šioje zonoje būtinas sienos sutvirtinimas



Det utlopp som inte behövs måste tätas med en blindstopp. (DN 20 3/4")



Endast en enhet möjlig, inte två samtidigt.



Avloppet måste klara mer än 50 l/min.

> 50 l/min



Drag vattenledningar till sidoduschar med fall.



Avlopp

Raindrain



Spolblock kompl. #15956000, medföljer ej leveransen



iBox i kombination med ett Exafill karinlopp med från- och överrinningsset (se sidan 66)

Exafill





Bazinis montavimas

Simetriškai besisukantis iBox pagrindą galima įstatyti tiek horizontaliai, tiek vertikaliai. Kai įrengiama vonios armatūra su apsauginiu rinkiniu, įmontuoti galima tik vertikaliai. "iBox" visada montuokite virš vonios, kad atsiradus problemai su funkcinėmis dalimis, vanduo galėtų į ją nubėgti!

iBox tinka tiek voniai, tiek ir dušui. Viena ranka valdomuose maišytuvuose / termostatuose su uždarymo vožtuvais ir skirstytuvais pirmenybė teikiama apatiniams išvadui. Jei reikalingas tik vienas išvadas, galite uždengti apatinį arba viršutinį išvadą. Nereikalingą išvadą sandariai uždenkite kaiščiu.

Turi būti išlyginti šalto ir karšto slėgio nelygumai.

Pagrindą sumontuokite taip, kad karšto vandens jungtis būtų kairėje, o šalto - dešinėje.

Montavimo gylis: nuo 80 mm iki 108 mm.

Ilgiklis 25 mm: #13595000

Ilgiklis 22 mm, esant nepakankamam sienos gyliui.:

#13593000 / #13596XXX / #13597XXX /

#15597000 / #19427000 / #97407XXX /

#98860000 / #13601000

Pagrindą galite sumontuoti pagal vietos sąlygas, montavimo pavyzdžiai pateikti 62 ir 63 psl.

A Montavimas į sieną.

B Montavimas į sieną su specialiais reguliuojamais 10 mm varžtais.

C Montavimas prie laikančios sistemos.

D Montavimas ant montavimo plokščių.

E Montavimas į sieną.

F Montavimas su montavimo rinkiniu #96615000

Įrengimo pavyzdžiai su nurodytais matmenimis ir vamzdyno dydžiais pateikti 68 puslapyje. Vartojamų simbolių paaiškinimai pateikti 67 puslapyje.

Montavimo instrukcijoje nurodyti išmatavimai idealiai tinka 1800 mm ūgio žmonėms. Galima keisti aukštį, bet tuomet keičiasi minimalus rekomenduojamas patalpos aukštis ir turi būti atsižvelgta į vandens jungties matmenų pasikeitimą. Sąnaudos išmatuotos artimomis realioms sąlygomis su reikiamomis dalimis (termostatu / maišytuvu / potinkiniu čiaupu).

Monatavimo patarimas

Norėdami įsukti jungiamuosius elementus, vamzdžiu įtvirtinkite iBox spaustuvoje.

Išplaukite

Pagal DIN 1988 / EN 1717 išplaukite visą įrangą. Rodyklės ant plaunamojo bloko rodo, kuriuos įvadus ir išvadų vamzdžius reikia sujungti tarpusavyje, pavyzdžiui, 1 šalto vandens išvadą su 2 karšto vandens išvadų. Jei reikalingas tik vienas išvadas, po pirmojo plovimo pasukite plaunamąjį bloką 90°.

iBox kartu su Exafill vonios čiaupu ir išleidimo bei apsauginės angos rinkiniais (žr. psl. 66)

Techniniai duomenys

Darbinis slėgis:	ne daugiau kaip 1 MPa
Rekomenduojamas slėgis:	0,1 - 0,5 MPa
Bandomasis slėgis:	1,6 MPa
(1 MPa = 10 barų = 147 PSI)	
Karšto vandens temperatūra:	ne daugiau kaip 80 °C
Rekomenduojama karšto vandens temperatūra:	65 °C
Atstumas tarp centrų:	G ^{3/4}
Prijungimas:	Šaltas vanduo dešinėje, karštas - kairėje
Laisvas vandens pralaidumas esant 0,3 MPa slėgiui:	
dušo maišytuvai:	32 l/min
Termostatas:	43 l/min
Termostatas su uždarymo vožtuvu:	26 l/min
Termostatas su uždarymo vožtuvu ir skirstytuvu:	26 l/min
Termostatas Highflow:	58 l/min
iControl:	30 l/min
maišytuvai voniai:	31 l/min // 24 l/min
maišytuvai voniai su integruota apsaugos sistema:	25 l/min // 24 l/min





X	Vonios vidurys / Dušo padėklo centras		Potinkinis uždarymo vožtuvas
Y	Matmuo Y = atstumas nuo dušo žarnos jungties centro iki čiaupo centro, padalintas iš 2 (jei įmanoma, taikykite prie plytelių).	 Quattro	„Quattro“ 4-krypčių perjungimas
	Šiltas vanduo	 Trio	Užtvarinis ir perjungimo vožtuvas „Trio Universal“
	Šaltas vanduo		Vonios įeiga
	Nuo • funkcionavimas garantuotas		Nenaudojamą išėjimą užaklinti. (DN 20 3/4")
	Šioje zonoje būtinas sienos sutvirtinimas		Nutekėjimo našumas turi būti ne mažesnis 50 l/min
	Vienu metu galima tik viena funkcija.	> 50 l/min	Nutekėjimas
	Privesti vamzdžius šoniniams purkštukams.		iBox kartu su Exafill vonios čiaupu ir išleidimo bei apsauginės angos rinkiniais (žr. psl. 66)
	Plaunamojo bloko jungtis #15956000, nėra pridedama	 Exafill	





Pripremna montaža

Rotacijsko simetrično tijelo jedinice iBox je univerzalno primjenjivo, kako horizontalno tako i vertikalno. Iznimku predstavlja montaža armatura za kade sa sigurnosnom kombinacijom, kod koje je moguća samo vertikalna ugradnja. Budući da kod kvara pojedinih dijelova iz iBox-a može otjecati voda, iBox je potrebno instalirati iznad kade kako bi voda mogla otjecati u kadu!

iBox je pogodan za ugradnju na tuš kade i kade. Kod jednoručnih miješalica za kade / termostata s ventilom za zatvaranje i ventilom selektora prioritetan je donji izlaz. Ako je potreban samo jedan ispust, po izboru se može priključiti gornji ili donji izlaz. Izlaz koji se ne koristi mora se zatvoriti čepom.

Velika razlika u pritisku između vruće i hladne vode mora biti izbalansirana.

Montirajte tijelo tako da se priključak tople vode nalazi na lijevoj, a hladne na desnoj strani.

Dubina ugradnje 80 - 108 mm.

Produljenje 25 mm: #13595000

Produljenje 22 mm (kod manje dubine ugradnje):

#13593000 / #13596XXX / #13597XXX /

#15597000 / #19427000 / #97407XXX /

#98860000 / #13601000

Tijelo se može montirati u skladu s uvjetima koji vladaju na mjestu postavljanja, primjeri montaže mogu se naći na stranicama 62 i 63.

A Direktna instalacija u zid.

B Direktna instalacija u zid sa 10 mm podesivim vijcima

C Montaža na sustav nosača.

D Instalacija u montažne ploče

E Instalacija u zid od cigle.

F Instalacija sa setom instalacijskih udloga #96615000

Primjeri instalacija s veličinama i dimenzijama vodova mogu se naći od stranice 68 nadalje. Pojašnjenje korištenih simbola nalazi se na stranici 67.

Montažne dimenzije navedene u uputama za montažu idealne su za osobe visine oko 1800 mm te se prema potrebi moraju prilagoditi konkretnoj visini korisnika. Pritom valja uzeti u obzir da se u slučaju promjene montažne visine mijenja i minimalna visina kao i da se tada mora uvažiti i promjena priključnih dimenzija. Vrijednosti potrošnje u praksi mjerene su s pripadajućim armaturama (termostat/mješač/podžbukni ventil).

Savjet u vezi montaže

Za uvrtanje priključnih elemenata iBox treba zategnuti u stegu uz pomoć komada cijevi.

Ispiranje

Kompletnu instalaciju treba isprati sukladno DIN 1988 / EN 1717. Stirelice na bloku prikazuju koji je dovod spojen s kojim odvodom, npr. hladna voda s odvodom 1, a topla voda s odvodom 2. Ukoliko je potreban samo jedan odvod, onda se nakon prvog ispiranja blok mora zakrenuti za 90°.

iBox u kombinaciji s Exafill ispustom u kadu s odvodnom i preljevnom garniturom (pogledaj stranicu 66)

Tehnički podaci

Najveći dopušteni tlak:	tlak 1 MPa
Preporučeni tlak:	0,1 - 0,5 MPa
Probni tlak:	1,6 MPa
(1 MPa = 10 bar = 147 PSI)	
Temperatura vruće vode:	tlak 80 °C
Preporučena temperatura vruće vode:	65 °C
Razmak od sredine:	G ³ / ₄
Spojevi:	hladna desno - topla lijevo
Slobodan protok na 0,3 MPa:	
Mješalica tuša:	32 l/min
Termostat:	43 l/min
Termostat sa izolacijskim ventilom:	26 l/min
Termostat sa ventilom za zatvaranje i ventilom selektora:	26 l/min
Termostat Highflow:	58 l/min
iControl:	30 l/min
Mješalica za kadu:	31 l/min // 24 l/min
Mješalica za kadu sa ugrađenim sigurnosnim sustavom:	25 l/min // 24 l/min





X

Sredina kade / Sredina tuš-kada



Podžbukni ventil

Y

Mjera Y = sredina priključka crijeva do sredine filtera kade podijeljeno sa 2 (eventualno prilagoditi rasteru pločica)



Quattro

Quattro četverostruki preusmjerač



Topla voda



Trio Universal ventil za zatvaranje i ventil selektora



Hladna voda

Trio



Zajamčena funkcija od • naviše



Ispust u kadu



U ovom je području potrebno ojačanje zida.



Potrebno je ostaviti zatvoren izlaz koji se ne koristi (DN 20 3/4")



Moguće je koristiti samo jedno trošilo, nikako dva istovremeno!



Protok vode mora biti veći od 50 l/min.

> 50 l/min



Položite vodovodne cijevi za bočni tuš s nagibom



Odvod

Raindrain



kompletni blok #15956000, Nije sadržano u isporuci!



Exafill

iBox u kombinaciji s Exafill ispustom u kadu s odvodnom i prelivnom garniturom (pogledaj stranicu 66)





Ham montaj

iBox'un rotasyon simetrik ana gövdesi yatay veya dikey şekilde çok amaçlı kullanılabilir. İstisna: Emniyet kombinasyonlu batarya armatürünün montajı sırasında sadece dikey montaj mümkündür. Fonksiyon parçalarının arızalanması durumunda iBox'tan şu çıkabileceği için, dışarı çıkan suyun küvete akabilmesi için iBox küvetin üzerine monte edilmelidir.

iBox hem küvet hem de duş tesisatı için uygundur. Tek elli küvet tipi bataryalarda / kesme ve divertör valfli termosatta alt çıkış önceliklidir. Sadece tek bir çıkış gerekiyorsa tercihen üst veya alt çıkış bağlanabilir. Gerekmeyen çıkış bir tapa ile contalanmalıdır.

Sıcak ve soğuk su bağlantıları arasında büyük basınç farklılıkları varsa, bu basınç farklılıklarının dengelenmesi gerekir.

Ana gövdeyi, sıcak su bağlantısı solda ve soğuk su bağlantısı sağda olacak şekilde takın.

Montaj derinliği 80 mm ila 108 mm.

Uzatma 25 mm: #13595000

Uzatma 22 mm (montaj derinliği düşükken):
#13593000 / #13596XXX / #13597XXX /
#15597000 / #19427000 / #97407XXX /
#98860000 / #13601000

Ana gövde yapısal koşullara uygun şekilde takılabilir, Montaj örneği Bkz. Sayfa 62 ve 63.

A Duvara direkt montaj

B Duvara direkt montaj. Burada, esnek mesafe tutucuları ile 10'lu sıkma vidaları kullanılarak.

C Taşıyıcı sistem üzerine montaj.

D Hazır ev montaj plakaları ya da hazır hücrelere montaj.

E Tuğla duvar Montajı

F Montaj rayı setiyle montaj #96615000

Ölçü verileri ve hat boyutlandırıcılı tesisat örnekleri Sayfa 68 itibarıyla bulunabilir. Kullanılan simgelerin açıklaması Sayfa 67'de.

Montaj kılavuzunda belirtilen montaj ölçüleri, yaklaşık 1.800 mm boyundaki kişiler için idealdir ve gerekirse adapte edilmelidir. Bu sırada, montaj yüksekliğinin değişmesiyle birlikte minimum yüksekliğin de değiştiğine ve bağlantı ölçülerindeki değişikliğin göz önüne alınması gerektiğine dikkat edilmelidir. Tüketim değerleri uygulamalı olarak ilgili armatürlerle (termostat/karıştırıcı/sıva altı valf) ölçülmüştür.

Montaj önerisi

Bağlantı parçalarını vidalamak için, iBox'u bir boru parçasıyla mengeneye sabitleyin.

Yıkama

Tüm tesisatı DIN 1988 / EN 1717'ye göre yıkayın. Yıkama bloğundaki oklar hangi beslemenin hangi çıkış hattına bağlı olduğunu gösterir, Örn; soğuk su 1. çıkışa ve sıcak su 2. çıkışa. Sadece bir çıkış kullanılıyorsa, birinci yıkama işleminden sonra yıkama bloğu 90° döndürülmelidir.

Çıkış ve taşma aksesuarlı bir Exafill batarya girişiyle bağlantılı iBox (bakınız sayfa 66)

Teknik bilgiler

İşletme basıncı:	azami 1 MPa
Tavsiye edilen işletme basıncı:	0,1 - 0,5 MPa
Kontrol basıncı:	1,6 MPa
(1 MPa = 10 bar = 147 PSI)	
Sıcak su sıcaklığı:	azami 80 °C
Tavsiye edilen su ısı:	65 °C
Bağlantı ölçüleri:	G ^{3/4}
Bağlantılar:	soğuk sağ - sıcak sol
0,3 MPa serbest akış:	
Duş miks bataryası:	32 l/dak
Termostat:	43 l/dak
Kesme valfli termostat:	26 l/dak
Kesme ve divertör valfli termostat:	26 l/dak
Termostat Highflow:	58 l/dak
iControl:	30 l/dak
Küvet miks bataryası:	31 l/dak // 24 l/dak
Entegre emniyet kombinasyonlu küvet miks bataryası:	25 l/dak // 24 l/dak





X

Küvetin ortası / Duş küvetinin ortası



Sıva altı valfi

Y

Y = Hortum bağlantı kavisinin ortasından küvet girişinin ortası arasındaki ölçü 2'ye bölünür (gerekirse fayans bölümlerine adapte edin).



Quattro

Quattro dört yönlü değiştirme



Sıcak su



Trio üniversal kapatma ve değiştirme valfi



Soğuk su

Trio



•'den itibaren fonksiyon garanti edilmiştir.



Küvet su girişi



Bu alanda duvarın kalınlaştırılması gereklidir.



Kullanılmayan çıkış bir kör tapayla izole edilmelidir. (DN 20 ¾")



Sadece bir tüketici mümkündür, aynı anda iki tüketici mümkün değildir.



Akış kapasitesi 50 l/dak üzerinde olmalıdır.

> 50 l/min



Yan duşların su hatlarını eğimli şekilde döşeyin.



Akış

Raindrain



Yıkama bloğu komple #15956000, Teslimat kapsamına dahil değildir



Exafill

Çıkış ve taşma aksesuarlı bir Exafill batarya girişiyle bağlantılı iBox (bakınız sayfa 66)



Montajı bakınız sayfa 89



Instalare brută

Partea principală simetric-rotațională a iBox-ului poate fi introdusă oricum, atât orizontal cât și vertical. Excepție la montarea robinetului căzii cu combinația de protecție, în acest caz este posibilă numai montarea pe verticală. Din cauza posibilității de defectare a componentelor din iBox, montați instalația iBox deasupra căzii pentru ca apa scursă să se evacueze prin cadă.

Cutia iBox este corespunzătoare atât pentru instalarea căzilor cât și a dușurilor. În cazul amestecătorului monomanual pentru cadă / termostat cu ventil de închidere și valvă comutator, este prioritară ieșirea inferioară. Dacă se necesită doar o singură ieșire, puteți racorda în funcție de necesități ieșirea inferioară sau cea superioară. Ieșirea nefolosită trebuie etanșată cu o garnitură de etanșare.

Diferențele de presiune mari între alimentarea cu apă rece și apă caldă trebuie echilibrate.

Corpul de bază este astfel construit încât racordul pentru apa caldă se află în partea stângă, iar cel pentru apa rece, în dreapta.

Adâncime de montare 80 - 108 mm

Prelungitor 25 mm: #13595000

Prelungitor 22 mm (în cazul montării la adâncime mică):
#13593000 / #13596XXX / #13597XXX /
#15597000 / #19427000 / #97407XXX /
#98860000 / #13601000

Corpul de bază se poate monta în funcție de condițiile existente, ca exemplu de montare, vedeți pagina 62 și 63.

A Montare pe perete.

B Montare pe perete. Cu distanțieri flexibili și țije filetate de 10 mm cu diblu.

C Montare pe sistem de susținere.

D Montare pe plăci de montare prefabricate sau celule prefabricate.

E Montare direct pe perete.

F Montare cu set de șine de montare #96615000

Exemplele de montaj cu specificații referitoare la dimensiuni și capacitate se găsesc începând de la pagina 68. Explicațiile simbolurilor utilizate se găsesc la paginile 67.

Dimensiunile de montare din instrucțiunile de montare sunt ideale pentru persoane cu o înălțime de cca. 1800 mm și trebuie modificate dacă este cazul. Aici trebuie să țineți cont de modificarea înălțimii de montare, deoarece în acest caz se va modifica și înălțimea minimă de montare și astfel trebuie modificate toate dimensiunile de racordare. Rile de consum au fost măsurate pe teren cu armăturile corespunzătoare (termostat, robinet de amestecare, supapă sub tencuială).

Indicații pentru montaj

Pentru înșurubarea piesei de racordare, cutia iBox este prevăzută cu o piesă tubulară strânsă în loculșul filetat.

Clătire

Toată instalația se spală în conformitate prevederile DIN 1988 / EN 1717. Săgețile de pe blocul de spălare, arată cum se face racordarea la conducta de ieșire, spre ex. apa rece cu ieșirea 1 și apa caldă cu ieșirea 2. În cazul în care este utilizată numai o ieșire, după prima spălare blocul de spălare trebuie rotit cu 90°.

Cutie iBox în combinație cu Exafill pe intrarea în cadă, cu un set pentru evacuare și deversare. (vezi pag. 66)

Date tehnice

Presiune de funcționare:	max. 1 MPa
Presiune de funcționare recomandată:	0,1 - 0,5 MPa
Presiune de verificare:	1,6 MPa
(1 MPa = 10 bar = 147 PSI)	
Temperatura apei calde:	max. 80°C
Temperatura recomandată a apei calde:	65°C
Interax racorduri:	G ^{3/4}
Racorduri:	rece - dreapta / cald - stânga
Debit cu curgere liberă la 0,3 MPa:	
Baterie duș:	32 l/min
Termostat:	43 l/min
Termostat cu ventil de închidere:	26 l/min
Termostat cu ventil de închidere și valvă comutator:	26 l/min
Termostat Highflow:	58 l/min
iControl:	30 l/min
baterie pentru cadă de baie:	31 l/min // 24 l/min
Baterie pentru cadă de baie cu combinație de siguranță integrată:	25 l/min // 24 l/min





X

Cadă de baie în mijloc / În mijlocul căzii de duș



Ventil montat sub tencuială

Y

Dimensiune Y = distanța între mijlocul racordului pentru furtună și intrare cadă împărțită la doi (eventual potrivit la suprafața tencuiei).



Quattro

Quattro valvă de inversare cu patru căi



Apă caldă



Trio valvă de închidere și de inversare universală



Apă rece

Trio



Începând de la • funcționarea este garantată.



Gură de admisiune



În această zonă este nevoie de întărirea peretelui.



Racordurile neutilizate trebuie acoperite cu dop etanș. (DN 20 3/4")



Se poate conecta numai un singur consumator, nu se pot conecta doi în același timp.



Capacitatea de evacuare trebuie să fie mai mare de 50 l/min.

> 50 l/min



Montați conductele de apă înclinate (în cădere) pentru dușurile laterale.



Deversor

Raindrain



Complet spălare #15956000, nu este inclus în setul livrat



Exafill

Cutie iBox în combinație cu Exafill pe intrarea în cadă, cu un set pentru evacuare și deversare. (vezi pag. 66)





Εγκατάσταση

Το συμμετρικό σώμα περιστροφής του iBox μπορεί να χρησιμοποιηθεί παντού, οριζόντια και κατακόρυφα. Εξαιρείται η συναρμολόγηση της μπαταρίας μπανιέρας με συνδυασμό ασφαλείας, εδώ είναι εφικτή μόνο η κατακόρυφη εγκατάσταση. Σε περίπτωση βλάβης των λειτουργικών τμημάτων, μπορεί να εξέρχεται νερό από το iBox, και θα πρέπει η μονάδα iBox να συναρμολογηθεί πάνω από την μπανιέρα, προκειμένου το εξερχόμενο νερό να ρέει μέσα στην μπανιέρα στην περίπτωση αυτή.

Το iBox είναι κατάλληλο για εγκατάσταση τόσο σε μπανιέρες όσο και σε ντουζιέρες. Σε αναμικτήρες μπανιέρας με μία λαβή / θερμοστάτη με βαλβίδα κλεισίματος και εκτροπής, προτεραιότητα έχει η κάτω εξαγωγή. Εάν είναι απαραίτητη μόνο μία εξαγωγή, μπορεί να συνδεθεί ανάλογα η άνω ή κάτω εξαγωγή. Η εξαγωγή που δεν θα χρησιμοποιείται πρέπει να ταπώνεται με τάπα.

Οι διαφορές της πίεσης μεταξύ της σύνδεσης κρύου και ζεστού νερού θα πρέπει να αντισταθμίζονται.

Τοποθετήστε τη βασική εγκατάσταση έτσι ώστε η σύνδεση ζεστού νερού να βρίσκεται αριστερά και του ψυχρού δεξιά.

Βάθος τοποθέτησης 80 -108 mm.

Επιμήκυνση 25 mm: #13595000

Σωλήνας επιμήκυνσης 22 mm (σε μειωμένο βάθος τοποθέτησης): #13593000 / #13596XXX / #13597XXX / #15597000 / #19427000 / #97407XXX / #98860000 / #13601000

Η βασική εγκατάσταση μπορεί να τοποθετηθεί σύμφωνα με τα δεδομένα του χώρου, παραδείγματα εγκατάστασης βλέπε σελίδα 62 και 63.

A Επίτοιχη τοποθέτηση

B Επίτοιχη εγκατάσταση. Χρησιμοποιήστε 10άρες βίδες -καρφιά με εύκαμπτα στηρίγματα.

C Συναρμολόγηση επί φέροντος συστήματος.

D Εγκατάσταση σε προκατασκευασμένες σανίδες ή σε προκάτ κελιά.

E Εγκατάσταση απευθείας στον τοίχο

F Εγκατάσταση με σετ σιδηροτροχιών συναρμολόγησης #96615000

Παραδείγματα εγκατάστασης με διαστάσεις και διαστασιολόγηση των σωλήνων θα βρείτε από τη σελίδα 68.

Επεξήγηση των χρησιμοποιούμενων εικονιδίων θα βρείτε στη σελίδα 67.

Οι διαστάσεις που αναφέρονται στις οδηγίες συναρμολόγησης είναι ιδανικές για άτομα με ύψος περ. 1800 mm και πρέπει, εάν χρειαστεί, να προσαρμοστούν. Στη φάση αυτή προσέξτε ότι με την αλλαγή του ύψους συναρμολόγησης τροποποιείται και το απαιτούμενο ελάχιστο ύψος, οπότε θα προκύψει αλλαγή και στις διαστάσεις σύνδεσης. Οι τιμές κατανάλωσης μετρήθηκαν στην πράξη με τα ανάλογα εξαρτήματα μπαταρίας (θερμοστάτης/αναμικτήρας/εντοιχισμένη βαλβίδα).

Συμβουλή για την εγκατάσταση

Για να βιδώσετε τεμάχια σύνδεσης, σφίξτε το iBox με ένα τεμάχιο σωλήνα στη μέγγενη.

Καθαρισμός

Ξεπλύνετε όλη την εγκατάσταση σύμφωνα με το DIN 1988 / EN 1717. Τα βέλη στο μπλοκ ξεπλύματος δείχνουν ποια παροχή συνδέεται με ποιο σωλήνα εξόδου, π.χ. κρύο νερό με έξοδο 1 και ζεστό νερό με έξοδο 2. Εάν χρειάζεται μόνο μία έξοδος, μετά την πρώτη διαδικασία ξεπλύματος, το μπλοκ ξεπλύματος πρέπει να γυρίσει κατά 90°

iBox σε συνδυασμό με είσοδο νερού μπατιέρας Exafill με απορροή και εξοπλισμό υπερχείλισης (βλ. Σελίδα 66)

Τεχνικά Χαρακτηριστικά

Λειτουργία πίεσης:	έως 1 MPa
Συνιστώμενη λειτουργία πίεσης:	0,1 - 0,5 MPa
Πίεση ελέγχου:	1,6 MPa
(1 MPa = 10 bar = 147 PSI)	
Θερμοκρασία ζεστού νερού:	έως 80 °C
Συνιστώμενη θερμοκρασία ζεστού νερού:	65 °C
Διαστάσεις σύνδεσης:	G $\frac{3}{4}$
Συνδέσεις:	κρύο δεξιά - ζεστό αριστερά
Ελεύθερη ροή στα 0,3 MPa:	
Μπαταρία (μεικτής) καταιονιστήρα:	32 l/min
Θερμοστάτης:	43 l/min
Θερμοστάτης με βαλβίδα κλεισίματος:	26 l/min
Θερμοστάτης με βαλβίδα κλεισίματος και εκτροπής:	26 l/min
Θερμοστάτης Highflow:	58 l/min
iControl:	30 l/min
Μπαταρία μπανιέρας:	31 l/min // 24 l/min
Μπαταρία μπανιέρας με ενσωματωμένο συνδυασμό ασφαλείας:	25 l/min // 24 l/min





X

Κέντρο μπανιέρας / Μέσον της ντουσιέρας



Χωνευτή βαλβίδα

Y

Μέγεθος X = από το μέσον του τόξου σύνδεσης του εύκαμπτου σωλήνα έως το μέσον της εισόδου της μπανιέρας, δια του 2 (ενδεχομένως να πρέπει να προσαρμοστεί στο ράστερ των πλακιδίων).

Ζεστό νερό



Κρύο νερό



Αυτή η λειτουργία διασφαλίζεται από το σημείο κι έπειτα



Σε αυτήν την περιοχή είναι απαραίτητη μία ενίσχυση του τοίχου.



Μόνο ένας χρήστης, όχι δύο ταυτόχρονα



Εγκαταστήστε τους αγωγούς νερού του καταιονιστήρα σώματος με κλίση.



Μπλοκ ζεπλύματος κομπλέ #15956000, δεν περιλαμβάνεται στον παραδοτέο εξοπλισμό



Quattro

Quattro τετράοδης μετατροπής



Trio

Trio Universal βαλβίδα κλεισίματος και εκτροπής



Είσοδος νερού στη μπανιέρα



Τα περιττά στόμια εξόδου πρέπει να στεγανοποιηθούν με ένα τυφλό πώμα. (DN 20 3/4")



> 50 l/min

Η αποχετευτική ικανότητα της βαλβίδας εκροής πρέπει να υπερβαίνει τα l/min.



Raindrain

Βαλβίδα εκροής



Exafill

iBox σε συνδυασμό με είσοδο νερού μπανιέρας Exafill με απορροή και εξοπλισμό υπερχείλισης (βλ. Σελίδα 66)





Surova montaža

Rotacijsko simetrično osnovno telo valja iBox je univerzalno vstavljivo, tako vodoravno kot tudi navpično. Izjema je le montaža armature za kopalno kad z zaščitnim kompletom, kjer je možna le navpična vgradnja. Pri okvari delov iBoxa lahko pride do izteka vode, zato iBox montiramo nad kadjó. Tako lahko voda odteka v kad!

iBox je primeren tako za instalacije za kopalne kadi kot tudi za prhe. Pri enoročnih baterijah za kopalno kad / termostatu z zapornim in preklopnim ventilom ima prednost spodnji odvod. Če potrebujete le en odvod, lahko po izbiri priklopite zgornji ali spodnji odvod. Neuporabljen odvod zatesnite s čepom.

Velike razlike v tlaku med priključkom za mrzlo in priključkom za toplo vodo je potrebno izravnati.

Osnovno telo vgradite tako, da se priključek za toplo vodo nahaja na levi, priključek za hladno vodo pa na desni strani.

Globina vgradnje 80 do 108 mm

Podaljšek 25 mm: #13595000

Podaljšek 22 mm (če zid ni dovolj globok):

#13593000 / #13596XXX / #13597XXX /

#15597000 / #19427000 / #97407XXX /

#98860000 / #13601000

Osnovno telo se lahko montira ustrezno gradbenim pogojem, montažne primere glejte na strani 62 in 63.

A Montaža na steno

B Montaža na steno. Tukaj z upogljivim distančnikom in 10-milimetrskimi vijaki.

C Montaža na nosilnem sistemu.

D Montaža na montažne plošče

E Montaža direktno v steno

F Montaža s pritrdilnim kompletom #96615000

Inštalacijske primere z navedbami mer in dimenzioniranjem cevi najdete od strani 68 dalje. Razlage uporabljene simbolov na straneh 67.

V navodilu za montažo navedene mere so idealne za osebe, visoke pribl. 1800 mm, in jih je treba po potrebi prilagoditi. Pri tem morate paziti na to, da se pri spremeni montajni višini spremeni tudi minimalna višina in je treba upoštevati spremembo priključnih mer. Vrednosti porabe so bile s pripadajočimi armaturami (termostat/mešalni ventil/podometni ventil) izmerjene v pogojih, ki ustrezajo predvideni dejanski uporabi.

Nasvet za montažo

Za uvitje priključnih kosov iBox s pomočjo kosa cevi vpnite v prirež.

Izpiranje

Kompletno instalacijo splaknite v skladu z DIN 1988 / EN 1717. Puščice na ventilu za vodo kažejo, kateri dovod je povezan s katerim odvodom, npr. mrzla voda z odvodom 1 in topla voda z odvodom 2. Če je potreben le en odvod, se mora po prvem splakovanju ventil za vodo obrniti za 90°.

iBox v kombinaciji z Exafill dovodom za kopalno kad z odtočno in pretočno garnituro (glejte stran 66)

Tehnični podatki

Delovni tlak:	maks. 1 MPa
Priporočeni delovni tlak:	0,1 - 0,5 MPa
Preskusni tlak:	1,6 MPa
(1 MPa = 10 bar = 147 PSI)	
Temperatura tople vode:	maks. 80 °C
Priporočena temperatura tople vode:	65 °C
Razdalja od sredine:	G ^{3/4}
Priključki:	mrzla desno - topla levo
Prost pretok pri 0,3 MPa:	
Mešalna baterija za prho:	32 l/min
Termostat:	43 l/min
Termostat z zapornim ventilom:	26 l/min
Termostat z zapornim in preklopnim ventilom:	26 l/min
Termostat Highflow:	58 l/min
iControl:	30 l/min
Mešalna baterija za kad:	31 l/min // 24 l/min
Mešalna baterija za kad z vgrajeno varnostno kombinacijo:	25 l/min // 24 l/min



Montaža glejte stran 89



X

Sredina kopalne kadi / Sredina pršne kadi



Podometni ventil

Y

Mera Y = sredina loka priključka za cev do sredine dotoka v kad deljeno z 2 (morebiti prilagoditi vzorcu ploščic)



Quattro

Quattro 4tiripotna prestavitev



Topla voda



Trio Universal zaporni in preklopni ventil



Mrzla voda

Trio



Od • je delovanje zagotovljeno.



Vtok v kad



V tem območju je potrebno ojačanje stene.



Izhod, ki ga ne potrebujete, zatesnite s čepom. (DN 20 3/4")



Mogoč je samo en uporabnik, ne dva istočasno.



Odtočna kapacitetamora znašati več kot 50 l/min.

> 50 l/min



Položite vodovodne cevi za stranske šobe z naklonom.



Raindrain

Odtok



Ventil za vodo, kpl. #15956000, Ni vključeno



Exafill

iBox v kombinaciji z Exafill dovodom za kopalno kad z odtočno in pretočno garnituro (glejte stran 66)



Montaža glejte stran 89



Toormontaaž

iBoxi sümmeetrilise ringlusega põhikorpused on universaalselt kasutatavad, nii horisontaalselt kui vertikaalselt. V.a. turvakombinatsiooniga vanniarmatuuri paigaldamisel, kus on võimalik ainult vertikaalne paigaldamine. Paigaldage iBox alati vanni kohale. Kui iBox'i osad lähevad katki, võib vesi vanni voolata!

iBox sobib niihästi vanni kui ka duši paigaldamiseks. Ühekäe-vannisegisti / katkestus- ja ümberlülitusklapiga termostaat puhul on alumine väljavool prioriteetne. Kui on vaja vaid ühte väljavoolu, saab soovi korral ülemise või alumise väljavoolu sulgeda. Mittevajalik väljavool tuleb korgiga tihendada.

Kui külma ja kuuma vee ühenduste surve on väga erinev, tuleb need tasakaalustada.

Põhikorpused paigaldada nii, et sooja vee liitmik oleks vasakul ja külma vee liitmik paremal.

Paigalduse sügavus 80 mm kuni 108 mm

pikendus 25 mm: #13595000

pikendus 22 mm (kui sein ei ole piisavalt paks):

#13593000 / #13596XXX / #13597XXX /

#15597000 / #19427000 / #97407XXX /

#98860000 / #13601000

Põhikorpused on võimalik paigaldada vastavalt ehituslikele asjaoludele, näiteid paigaldamise kohta vt lk 62 ja 63.

A Seinale paigaldamine.

B Seinale paigaldamine. Siin reguleeritava vahehooldikuga, kasutades 10 mm tikkpolte.

C Kandursüsteemile paigaldamine.

D Paigaldamine kiirmontaažiplaatidele või valmiskabiini.

E Paigaldamine otse seinale.

F Paigaldamine kinnussiinidega #96615000

Paigaldusnäited koos mõõtude info ja voolikute suurus-
tega leiate alates leheküljest 68. Kasutatud sümbolite
selgitused leiate lehekülgedelt 67.

Paigaldusjuhendis esitatud paigaldusmõõdud on ideaalsed u. 1800 mm pikkustele inimestele ning vajadusel tuleb neid kohandada. Seejuures tuleb silmas pidada, et muutunud paigalduskõrguse korral muutub ka minimaalne kõrgus ning tuleb arvestada, et erinevad on ka ühendusmõõdud. Tarbimisväärtusi mõõdeti praktikas juurdekuuluvate armatuuridega (termostaat/segisti/krohvalune ventiil).

Paigaldusnäpunäide

Ühendusdetailide sissekeeramiseks kinnitage iBox toru abil kruustangidesse.

Äravoolu süsteem

Pärast paigaldamist vastavalt standardile DIN 1988 / EN 1717 läbi pesta. Loputusploki olevad nooled näitavad, milline pealevool on millise äravoolumitoruga seotud, nt külm vesi äravoolumuga 1 ja soe vesi äravoolumuga 2. Kui on vaja ainult ühte äravoolumu, tuleb loputusploki pärast esimest loputust 90° keerata.

iBox ühenduses ära- ja ülevoolumugarnituuriga Exafilli vanni sissevooluga (vt lk 66)

Tehnilised andmed

Töörõhk	maks. 1 MPa
Soovitav töörõhk:	0,1 - 0,5 MPa
Kontrollsurve:	1,6 MPa
(1 MPa = 10 baari = 147 PSI)	
Kuuma vee temperatuur:	maks. 80 °C
Soovitav kuuma vee temperatuur:	65 °C
distants keskelt:	G ^{3/4}
ühendused:	külm paremal, kuum vasakul
Äravoolumu surve 0,3 MPa	
dušisegisti:	32 l/min
Termostaat:	43 l/min
Katkestusklapiga termostaat:	26 l/min
Katkestus- ja ümberlülitusklapiga termostaat:	26 l/min
Termostaat Highflow:	58 l/min
iControl:	30 l/min
Vanni-duši segisti:	31 l/min // 24 l/min
Turvasüsteemiga vanni-duši segisti:	25 l/min // 24 l/min





X

Vanni keskkohrt / Dušivanni kese



peiteklapp

Y

Mõõt Y = vooliku seinaväljavoolu keskmest vannitäituri keskele jagatud 2-ga (võimalusel kohandage keraamiliste plaatide asetusega).



Quattro-liitmik

Quattro



Soe vesi



Katkestus- ja ümberlülitusklapp Trio Universal



Külm vesi

Trio



Alates • on funktsioneerimine garanteeritud



Vanni kraan



Selles alas tuleb seinatugevdada.



Mittevajalik väljavool tuleb sulgeda korkiga. (DN 20 3/4")



Võimalik on ainult üks funktsioon, mitte kaks korraga.



Äravoolu jõudlus peab olema suurem kui 50 l/min.

> 50 l/min



Paigaldage kehaduši jaoks vajalikud veeto-
rud kaldega.



Äravool

Raindrain



Loputusplokk kpl. #15956000, ei sisaldu komplektis



iBox ühenduses ära- ja ülevoolugarnituuri-
ga Exafilli vannisseveooluga (vt lk 66)

Exafill





Cauruļu montāža

Rotācijā simetriskais iBox korpuss ir izmantojams universāli - gan horizontāli, gan vertikāli. Izņemot gadījumus, kad veic vannas armatūras montāžu ar drošības kombināciju - šādos gadījumos iespējama tikai vertikāla iebūve. Tā kā funkcionālo detaļu bojājuma gadījumā no iBox daļas var izplūst ūdens, iBox jāmontē virs vannas, lai izplūstošais ūdens varētu notecēt vannā!

iBox ir piemērots gan vannu, gan dušu instalācijām. Vannas jaucējkrāniem ar vienu sviru / termostatiem ar noslēgvārstu un pārslēdzējvārstu apakšējai izplūdes ierīcei ir prioritāte. Ja ir nepieciešama tikai viena izplūdes ierīce, ar pēc izvēles pieslēgt augšējo vai apakšējo izplūdes ierīci. Neizmantojot izplūdes ierīci jānoblivē ar aizbāzni.

Jāizlīdzina spiediena atšķirības starp aukstā un karstā ūdens pievadiem.

Korpusu iebūvējiet tā, lai siltā ūdens pieslēgums atrastos pa kreisi un aukstā ūdens pieslēgums - pa labi.

Iebūvēšanas dziļums 80 mm līdz 108 mm.

Pagarinājums 25 mm: #13595000

Pagarinājums 22 mm (ja iebūvēšanas dziļums nav pietiekams): #13593000 / #13596XXX / #13597XXX / #15597000 / #19427000 / #97407XXX / #98860000 / #13601000

Korpusu iespējams iebūvēt atbilstoši konstrukcijas īpašībām, montāžas piemērus skat. 62. un 63. lpp.

A Instalācija pie sienas.

B Instalācija pie sienas. Šeit ar elastīgu starpliku un 10 mm izmēra montāžas skrūvēm.

C Montāža uz balstu sistēmu.

D Instalācija uz gataviem montāžas paneļiem vai gataviem elementiem.

E Instalācija tieši sienā.

F Instalācija ar montāžas sliežu komplektu #96615000

Uzstādīšanas piemēri ar izmēriem un vadu izkārtojumu atrodami, sākot no 68 lappuses. Lietoto simbolu izskaidrojums atrodams 67 lappusē.

Montāžas instrukcijās dotie montāžas izmēri ir ideāli piemēroti personām, kuru augums ir apm. 1800 mm. Nepieciešamības gadījumā šie izmēri ir jāpielāgo. Šeit ir jāņem vērā, ka mainoties montāžas augstumam, mainās arī minimālais augstums, un jāņem vērā arī pieslēgšanas izmēru izmaiņas. Patēriņš ir noteikts praktiski ar atbilstošu armatūru (termostats/maisītājs/zemapmetuma vārsts).

Montāžas padoms

Lai iegrieztu savienojuma elementus, iBox ar caurules palīdzību nostipriniet skrūvspilēs.

Skalošana

Izskalojiet visu instalāciju atbilstoši DIN 1988 / EN 1717. Bultiņas uz skalošanas bloka parāda, kurš pievads ir savienots ar attiecīgo izplūdes cauruli, piem., aukstais ūdens ar 1. izplūdi un siltais ūdens ar 2. izplūdi. Ja nepieciešama tikai viena izplūde, pēc pirmās skalošanas reizes par 90° jāpagriež skalošanas bloks.

iBox kombinācijā ar Exafill vannas ieplūdi ar noplūdes un pārplūdes garnitūru (skat. lpp. 66)

Tehniskie dati

Darba spiediens:	maks. 1 MPa
leteicamais darba spiediens:	0,1 - 0,5 MPa
Pārbaudes spiediens:	1,6 MPa
(1 MPa = 10 bar = 147 PSI)	
Karstā ūdens temperatūra:	maks. 80 °C
Ieteicamā karstā ūdens temperatūra:	65 °C
Pieslēguma izmēri:	G ^{3/4}
Pieslēgumi:	aukstais pa labi - karstais pa kreisi
Brīva caurplūde, ja ir 0,3 MPa:	
Dušas jaucējkrāns:	32 l/min
Termostats:	43 l/min
Termostats ar slēgvārstu.:	26 l/min
Termostats ar noslēgvārstu un pārslēdzējvārstu.:	26 l/min
Termostats Highflow:	58 l/min
iControl:	30 l/min
Vannas/ dušas jaucējkrāns:	31 l/min // 24 l/min
Vannas/ dušas jaucējkrāns ar integrētu drošības kombināciju:	25 l/min // 24 l/min





X

Vannas vidus / Dušas paliktņa vidus



Zemapmetuma ventilis

Y

Izmērs Y = šļūtenes savienojuma loka vidu līdz vannas ietece vidum dalīt ar 2 (eventuāli piemērot frīžu rakstam)



Quattro

Četrvirzienu pārslēgs



Siltais ūdens



Trīsvirzienu universālais noslēgvārsts un pārslēdzējvārsts



Aukstais ūdens

Trio



No • funkcija nodrošināta



Vannas tekne



Šajā zonā ir nepieciešams pastiprināt sienu.



Neizmantoto izteku aizbāzt ar aizbāzni. (DN 20 3/4")



Iespējams tikai viens patērētājs, nedrīkst vienlaikus būt divi patērētāji.



Noteces veiktspējai jābūt vairāk nekā 50 l/min.

> 50 l/min



Montēt ūdens cauruļvadus sānu (ķermeņa) dušām ar atbilstošu slīpumu.



Notece

Raindrain



Skalošanas bloks, kompl. #15956000, komplektā netiek piegādāts



iBox kombinācijā ar Exafill vannas iepļūdi ar noplūdes un pārplūdes garnitūru (skat. lpp. 66)

Exafill





Pripremna montaža

Rotaciono simetrično telo jedinice iBox je univerzalno primenljivo, kako horizontalno tako i vertikalno. Izuzetak predstavlja montaža armatura za kade sa sigurnosnom kombinacijom, jer je tu moguća samo vertikalna ugradnja. Pošto kod kvara pojedinih delova iz iBox-a može iscureti voda, iBox se mora instalirati iznad kade, tako da voda može oticati u kadu!

IBox je pogodan za ugradnju na tuš i instalaciju za kade. Kod jednoručnih mešača za kadu / termostata s ventilom za zatvaranje i preklopnim ventilom prioritetan je donji izlaz. Ukoliko je potreban samo jedan ispust, po izboru može da se priključi gornji ili donji izlaz. Izlaz koji se ne koristi mora da se zatvori čepom.

Velika razlika u pritisku između vruće i hladne vode mora biti izbalansirana.

Montirajte telo tako da priključak tople vode bude sa leve, a hladne sa desne strane.

Dubina ugradnje 80 - 108 mm.

Produžetak 25 mm: #13595000

Produžetak 22 mm (kod manje dubine ugradnje):

#13593000 / #13596XXX / #13597XXX /

#15597000 / #19427000 / #97407XXX /

#98860000 / #13601000

Telo može da se montira u skladu sa uslovima na mestu ugradnje, za primere montaže vidi strane 62 i 63.

A Direktna instalacija na zid.

B Direktna instalacija na zid s držačem odstojanja pomoću 10 mm podesivih zavrtnja.

C Montaža na sistem nosača.

D Instalacija na gotove montažne ploče ili gotove ćelije.

E Instalacija direktno u zid.

F Instalacija sa setom instalacionih šina #96615000

Primeri instalacija sa veličinama i dimenzijama vodova mogu se naći od stranice 68 nadalje. Objašnjenje korišćenih simbola nalazi se na stranici 67.

Montažne dimenzije navedene u uputstvu za montažu idealne su za osobe visine oko 1800 mm, tako da se po potrebi moraju prilagoditi konkretnoj visini korisnika. Pri tome treba uzeti u obzir da se prilikom promene montažne visine menja i minimalna visina kao i da se u tom slučaju mora uvažiti i promena priključnih dimenzija. Vrednosti potrošnje su u praksi merene sa pripadajućim armaturama (termostat/mešač/uzidni ventil).

Savet u vezi montaže

Za uvrtnanje priključnih elemenata iBox treba zategnuti u stegu uz pomoć komada cevi.

Ispiranje

Kompletnu instalaciju treba isprati u skladu sa normom DIN 1988 / EN 1717. Strelce na bloku prikazuju koji je dovod spojen sa kojim odvodom, npr. hladna voda sa odvodom 1, a topla voda sa odvodom 2. Ukoliko je potreban samo jedan odvod, onda se nakon prvog ispiranja blok mora zakrenuti za 90°.

iBox u kombinaciji sa Exafill dotokom kade sa odvodnom i prelivnom garniturom (vidi stranu 66)

Tehnički podaci

Radni pritisak:	maks. 1 MPa
Preporučeni radni pritisak:	0,1 - 0,5 MPa
Probni pritisak:	1,6 MPa
(1 MPa = 10 bar = 147 PSI)	
Temperatura vruće vode:	maks. 80 °C
Preporučena temperatura vruće vode:	65 °C
Rastojanje između centara priključaka:	G ^{3/4}
Priključci:	hladna voda desno - topla levo
Slobodan protok na 0,3 MPa:	
Mešač tuša:	32 l/min
Termostat:	43 l/min
Termostat s ventilom za zatvaranje:	26 l/min
Termostat s ventilom za zatvaranje i preklopnim ventilom:	26 l/min
Termostat Highflow:	58 l/min
iControl:	30 l/min
Mešač za kadu:	31 l/min // 24 l/min
Mešač za kadu s ugrađenim sigurnosnim sistemom:	25 l/min // 24 l/min





X

Sredina kade / Sredina tuš-kada



Uzidni ventil

Y

Mera Y = sredina priključnog luka creva do sredine dotoka kade podeljeno sa 2 (eventualno prilagoditi rasteru pločica).



Quattro

Quattro četverostruki preusmerivač



Topla voda



Trio Universal ventil za zatvaranje i preklopni ventil



Hladna voda

Trio



Od • je funkcija zagarantovana.



Dotok kade



U ovoj oblasti je potrebno ojačanje zida.



Izlaz koji se ne koristi, mora se zatvoriti slepim čepom. (DN 20 3/4")



Moguće je koristiti samo jedan potrošač, nikako dva istovremeno!



Kapacitet odvoda mora biti veći od 50 l/min.

> 50 l/min



Položite vodovodne cevi za bočni tuš s nagibom.



Ispust

Raindrain



kompletan blok #15956000, Nije sadržano u isporuci



Exafill

iBox u kombinaciji sa Exafill dotokom kade sa odvodnom i prelivnom garniturom (vidi stranu 66)





Råmontasje

Det rotasjonsymetriske baseelementet til iBox kan brukes universelt dvs. horisontalt og vertikalt. Et unntak er ved montasje av kararmatur med sikkerhetskombinasjon. Da er det kun mulig med vertikal montasje. Ettersom det kan lekke vann ut av iBoxen ved en defekt, skal iBoxen monteres over badekaret, slik at vannet som lekker ut kan renne ned i badekaret.

iBoxen egner seg både for installasjon på dusj eller badekar. Ved enhånd-blandebatteri for badekar / termostat med sperre- og omstillingsventil prioriteres nedre utgangen. Dersom kun en utgang brukes, kan det valgfritt kobles til øvre eller nedre utgang. Utgangen som ikke brukes må tettes med en plugg.

Store trykkdifferanser mellom kaldt- og varmtvannstilkoblinger skal utlignes.

Baseelementet bygges inn slik at varmtvannstilkobling er på venstre og kaldtvannstilkobling er på høyre side.

Innbyggingsdybde 80 mm til 108 mm.

Forlengelse 25 mm: #13595000

Forlengelse 22 mm (ved liten montasje dybde):

#13593000 / #13596XXX / #13597XXX /

#15597000 / #19427000 / #97407XXX /

#98860000 / #13601000

Baseelementet kan monteres iht. byggmessige forhold, se montasje-eksempel på side 62 og 63.

A Installasjon på vegg

B Installasjon på vegg. Her med fleksible avstandsholdere via spesialskruer.

C Montasje på bæresystem.

D Installasjon på ferdighus-montasjeplater eller prefabrikkert celler.

E Installasjon rett på vegg.

F Installasjon med sett av montasjeskinner #96615000

Installasjonseksempel med målangivelser og ledningsdimensjoner finns fom. side 68. Forklaring for brukte symboler på side 67.

Monteringsmål i monteringsveiledningen er beregnet for personer som er omtrent 1800 mm høye, målene skal eventuell tilpasses om nødvendig. Her skal man passe på at ved endrede monteringsmålene blir minstehøyden endret, og det må tas hensyn til de endrede tilkoblingsmålene. Forbruksverdiene måles ved normal bruk med tilhørende armatur (temostat/blandebatteri/innmurt ventil).

Montasje-tipp

For å skru inn koblinger skal iBoxen settes fast i en skrutikke ved hjelp av et rør.

Spyle

Komplett installasjon spyles iht. DIN 1988 / EN 1717. Pilene på spyleblokken indikerer hvilke tilløp som er koblet sammen med hvilken utgangsledning, f.eks. kaldtvann med utgang 1 og varmtvann med utgang 2. Hvis det kun er nødvendig med en utgang, skal spyleblokken dreies med 90° etter den første spylingen.

iBox i kombinasjon med Exfill karinnløp med avløps- og overflytgarnityr (se side 66)

Tekniske data

Driftstrykk	maks. 1 MPa
Anbefalt driftstrykk:	0,1 - 0,5 MPa
Prøvetrykk	1,6 MPa
(1 MPa = 10 bar = 147 PSI)	
Varmtvannstemperatur	maks. 80 °C
Anbefalt temperatur for varmt vann	65 °C
Tilkoblingsmål:	G ^{3/4}
Tilkoblinger:	kaldt høyre - varm venstre
Fri gjennomstrømning ved 0,3 MPa:	
Dusj-blandebatteri:	32 l/min
Termostat:	43 l/min
Termostat med sperreventil:	26 l/min
Termostat med sperre- og omstillingsventil:	26 l/min
Termostat Highflow:	58 l/min
iControl:	30 l/min
Blandebatteri for badekar:	31 l/min // 24 l/min
Blandebatteri for badekar med integrert sikkerhetskombinasjon:	25 l/min // 24 l/min





X

Midten av badekaret / Midten på dusjkar



Innfelt ventil

Y

Mål Y = Midten til slangetilkoblingsbue t.o.m. badekarinnløp delt på 2 (eventuelt skal fliseraster tilpasses).



Quattro fire-veis omstilling

Quattro



Varmtvann



Trio universal stenge- og omstillingsventil



Kaldtvann

Trio



F.o.m. • er funksjonen garantert



Innløp badekar



I dette området skal veggen forsterkes.



Utgangen som ikke brukes kan tettes med en blindplugg. (DN 20 3/4")



Kun en forbruker mulig, ikke to samtidig.



Avløp ytelse skal være mer enn 50 l/min.

> 50 l/min



Vannledninger for sidedusjer installeres med fall.



Avløp



Raindrain



Spyleblokk kpl. #15956000, ikke med i leveransen



Exafill

iBox i kombinasjon med Exfill karinnløp med avløps- og overflytgarnityr (se side 66)



Montasje se side 89



Първичен монтаж

Ротационно-симетричното основно тяло на iBox може да се приложи универсално, хоризонтално и вертикално. Изключение прави монтажът на арматурата за вана с комплект предпазители, тук е възможен само вертикален монтаж. Тъй като при дефект на функционалните части около iBox може да изтече вода, iBox трябва да се монтира над ваната, за да може изтичащата вода да се отича във ваната!

iBox е подходяща както за инсталации на вани, така и на разпръскватели. При смесители за вана с една ръкохватка / термостат със спирателен и превключващ клапан първостепенен е долният извод. Ако е необходим само един извод може да бъде свързан по избор горният или долният извод. Излишният извод може да се уплътни с пробка.

Големите разлики в налягането между изводите за студената и топлата вода трябва да се изравняват.

Основното тяло се монтира така, че изводът за топла вода да се намира отляво, а за студена вода отдясно.

Монтажна дълбочина 80 мм до 108 мм.

Удължител 25 мм: #13595000

Удължител 22 мм (при малка монтажна дълбочина):
#13593000 / #13596XXX / #13597XXX /
#15597000 / #19427000 / #97407XXX /
#98860000 / #13601000

Основното тяло може да се закрепя на стената в съответствие с конструктивните дадености, примери за монтаж на стр. 62 и 63.

A Инсталация на стената.

B Инсталация на стената. Тук с гъвкава разпънка с помощта на комбинирани болтове 10.

C Монтаж на трегерната система.

D Инсталация върху монтажни плочи на сглобяеми сгради или готови клетки.

E Инсталация директно в стената.

F Инсталация с набор монтажни шини #96615000

Примери за инсталация с данни за размери и определяне на размерите на тръбопроводите можете да намерите от стр. 68 нататък. Разяснения на използваните символи на стр. 67.

Посочените в ръководството за монтаж монтажни мерки са идеални за лица с ръст от припл. 1800 мм и трябва съответно да се пригледат. При това обърнете внимание на това, при променена монтажна височина се променя минималната височина и трябва да бъде взета под внимание промяната на присъединителните размери. Стойностите за разхода бяха измерени във връзка с практиката със съответните арматури (термостат/смесител/клапан за полагане в мазилката).

Съвети при монтаж

За да завинтите присъединителните елементи затегнете iBox с помощта на тръбен елемент в менгеме.

Промиване

Промийте цялата инсталация съгласно DIN 1988 / EN 1717. Стрелките на промивачия блок показват, кой вход с кой изходящ тръбопровод е свързан, напр. студена вода с извод 1, а топла вода с извод 2. В случай, че е необходим само един изход, след първия процес на промиване промивачият блок трябва да се завърти на 90°.

iBox в комбинация с вход за вана Exafill с гарнитура за изтичане и преливане. (вижте стр. 66)

Технически данни

Работно налягане:	макс. 1 МПа
Препоръчително работно налягане:	0,1 - 0,5 МПа
Контролно налягане:	1,6 МПа
(1 МПа = 10 bar = 147 PSI)	
Температура на горещата вода:	макс. 80 °C
Препоръчителна температура на горещата вода:	65 °C
Присъединителни размери:	G ³ / ₄
Изводи:	студено отдясно – топло отляво
Свободен поток при 0,3 МПа:	
Смесител на разпръсквателя:	32 л/мин
Термостат:	43 л/мин
Термостат със спирателен клапан:	26 л/мин
Термостат със спирателен и превключващ клапан:	26 л/мин
Термостат Highflow:	58 л/мин
iControl:	30 л/мин
Смесител за вана:	31 л/мин // 24 л/мин
Смесител на вана с интегриран комплект предпазители:	25 л/мин // 24 л/мин



Монтаж вижте стр. 89



X

Среда на ваната / Среда на коритото на душ-кабината



Клапан за мазилка

Y

Мярка Y = Среда на присъединителното коляно на маркуча до входа на ваната разделено на 2 (евентуално изравнете към растера на плочките).



Четирипътно превключване Quattro



Топла вода



Спирателен и превключващ клапан Trio Universal



Студена вода

Trio



От • функцията е гарантирана.



Вход за вана



В тази област е необходимо подсилване на стената.



Излишният извод може да се уплътни с глуха пробка. (DN 20 3/4")



Възможен е само един консуматор, не два едновременно.



Мощността на изтичане трябва да бъде повече от 50 л/мин.

> 50 l/min



Водопроводните линии за страничните разпръскватели полагайте с наклон.



Отвеждане

Raindrain



Изплакващ блок компл. #15956000, не се съдържа в обема на доставка



iBox в комбинация с вход за вана Exafill с гарнитура за изтичане и преливане. (вижте стр. 66)

Exafill



Монтаж вижте стр. 89



Montimi në vija të trasha

Trupi bazë me rotacion simetrik i iBox-it mund të përdoret në mënyrë universale, si horizontalisht, ashtu edhe vertikalisht. Me përjashtim të montimit të armaturës së vaskës me kombinim me elemente sigurie. Kështu është i mundur vetëm montimi vertikal. Meqë në rast të ndonjë defekti të pjesëve funksionale mund të rrjedhë ujë nga iBox-i, është e nevojshme që iBox-i të montohet sipër vaskës, me qëllim që uji që rrjedh të derdhet në vaskë!

iBox-i është i përshtatshëm si për instalimin me vaskën, ashtu edhe me dushin. Te rubinetet me një dorezë për përzjerjen e ujit për vaskën / termostati me ventil bllokues dhe ventil për ndërrimin e pozicionit ka prioritet dalja e poshtme. Nëse nevojitet vetëm një dalje, mund të mbyllet një prej tyre, ajo e sipërme ose e poshtme, sipas dëshirës. Dalja që nuk nevojitet duhet të bllokohet me një tapë.

Ndryshimet e mëdha të presionit mes lidhjeve të ujit të ftohtë dhe atij të ngrohtë duhen ekuilibruar.

Trupi bazë duhet montuar në atë mënyrë që lidhja e ujit të ngrohtë të jetë në të majtë dhe ajo e ujit të ftohtë në të djathtë.

Thellësia e montimit 80 mm deri 108 mm.

Zgjatësi 25 mm: #13595000

Zgjatësi 22 mm (lartësia e montimit jo e madhe):

#13593000 / #13596XXX / #13597XXX /

#15597000 / #19427000 / #97407XXX /

#98860000 / #13601000

Trupi bazë mund të montohet duke iu përshtatur kushteve ndërtimore. Shembuj të montimit gjinden në faqet 62 dhe 63.

A Instalimi në mur.

B Instalimi në mur. Këtu me distancues të lakueshëm përmes vidhave lidhëse 10-she.

C Montimi në sistemin mbajtës.

D Instalimi në pllakat e montimit të shtëpive parafabrikate ose në qelizat e gatshme.

E Instalimi direkt në mur.

F Instalimi me kompletin e shinave të montazhit #96615000

Shembujt e instalimit me përmasat dhe dimensionimet e tubacioneve mund t'i gjeni nga faqja 68. Shpjegimi i simboleve të përdorura gjendet në faqen 67.

Përmasat e montimit të cekura në udhëzimin teknik të montimit janë ideale për persona me gjatësi afro 1800 mm (180 cm) dhe eventualisht duhen përshtatur. Këtu duhet pasur parasysh që me ndryshimin e lartësisë së montimit, ndryshon edhe lartësia e cekur minimale si dhe ndryshimi i përmasave të lidhjeve. Vlerat e konsumit janë matur praktikisht me pajisje përkatëse të valvulave/pajisjeve të ujit (termostati / miksuksi / ventili nën sipërfaqës suvar).

Këshilla rreth montimit

Për të rrotulluar lidhjet duhet lidhur iBox/ me anë të një pjese të tubit në morsë.

Shpërlarje

I gjithë instalimi duhet shpërlarë në bazë të normës DIN 1988 / EN 1717. Shigjetat në bllokun shpërlarës tregojnë se cila hyrje është lidhur me cilën dalje, p.sh. uji i ftohtë me daljen 1 dhe uji i ngrohtë me daljen 2. Nëse nevojitet vetëm një dalje, atëherë pas shpërlarjes së parë blloku shpërlarës duhet rrotulluar 90°.

iBox-i në kombinim me në garniturë dalje dhe rrjedhëse Exafill hyrjen e vaskës (shih faqen 66)

Të dhëna teknike

Presioni gjatë punës	maks. 1 MPa
Presioni i rekomanduar:	0,1 - 0,5 MPa
Presioni për provë:	1,6 MPa
(1 MPa = 10 bar = 147 PSI)	
Temperatura e ujit të ngrohtë	maks. 80°C
Temperatura e rekomanduar e ujit të ngrohtë:	65°C
Përmasat e lidhjeve:	G ^{3/4}
Lidhjet:	i ftohtë djathtas - i ngrohtë majtas
Rrjedhja e lirë me 0,3 Mpa:	
Spërkatësja me ujë të përzier:	32 l/min
Termostati:	43 l/min
Termostat me ventil bllokues:	26 l/min
Termostati me ventil bllokues dhe ventil për ndërrimin e pozicionit:	26 l/min
Termostati Highflow:	58 l/min
iControl:	30 l/min
Rubineti i vaskës:	31 l/min // 24 l/min
Rubineti i vaskës me kombinim të integruar të sigurisë:	25 l/min // 24 l/min





X

Mesi i vaskës / Mesi i vaskës së dushit



Ventili i suvajës

Y

Përmasa Y = mesi i harkut të lidhjes së zorrës deri tek mesi i hyrjes së vaskës pjesëtim për 2 (eventualisht i duhet përshtatur këndit të pllakave të murit).



Quattro

Valvul devijuese Quattro me katër drejtime



Uji i ngrohtë



Trio

Valvul universale Trio për bllokim dhe devijim



Uji i ftohtë



Nga • është i mundur funksioni.



Vrima për mbushjen e vaskës



Në këtë zonë është i nevojshëm një përforcim i murit.



Dalja që nuk nevojitet duhet izoluar me tapë qorre. (DN 20 3/4")



Ekziston mundësia vetëm për një konsumator, jo për dy njëkohësisht.



> 50 l/min

Kapaciteti i shkarkimit duhet të jetë më shumë se 50 l/minutë.



Vendosni tubacionet e ujit për spërkatëset anësore me pjerrësi.

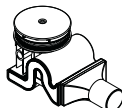

Raindrain

Shkarkimi



Blloku shpëlarës komplet #15956000, nuk përfshihet në vëllimin e furnizimit



Exafill

iBox-i në kombinim me në garniturë dalëse dhe rrjedhëse Exafill hyrjen e vaskës (shih faqen 66)



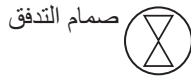

منتصف حوض الاستحمام / بانيو مزود بدش في المنتصف **X**

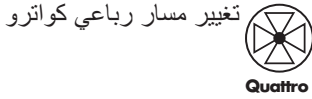

البعد γ = مركز مرفق مخرج حائط الخرطوم إلى مركز حشوة الحمام مقسوماً على 2 (مطابق لشكل البلاطة إن أمكن). **Y**

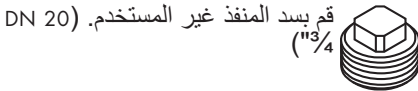
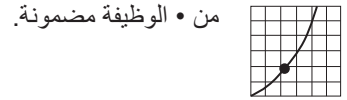
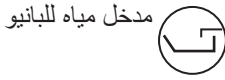
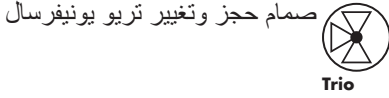

يلزم هذا في النطاق وجود تقوية للحائط.

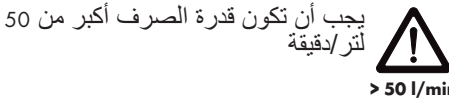

لا يمكن القيام بأكثر من وظيفة واحدة.



قم بتركيب مواسير المياه للعادي المنحدر.

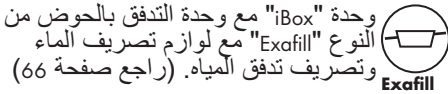

قارنة وحدة الغسل #15956000, غير مدرج مع المحتويات المسلمة



تركيب الأنابيب

تعد أبعاد التركيب الواردة في إرشادات التركيب هذه مثالية بالنسبة للأشخاص الذين يبلغ طولهم حوالي 1800 مم. ويمكن تغيير الأبعاد عند الحاجة. وبالتالي سيتغير الحد الأدنى للارتفاع في حالة تغيير ارتفاع التركيب، مما يعني الأخذ في الاعتبار تغيير أبعاد التوصيل. تم قياس قيم الاستهلاك طبقاً للخبرة العملية في استعمال خلاطات المياه الخاصة بذلك (ثرموستات/خلاط/صمام تحت الملائط).

نصائح خاصة بعملية التركيب

من أجل لف الوصلات، يجب تركيب وحدة "iBox" في الملزمة باستخدام أنبوبة.

نظام سريان الماء عبر المواسير

يجب غسل الوحدة المركبة بالكامل وفقاً للمعيار DIN 1988/EN 1717. تحدد الأسهم الموجودة على وحدة الغسل أي فرع يرتبط بأية وصلة منفذ، على سبيل المثال: المياه الباردة مع المنفذ رقم 1، والمياه الساخنة مع المنفذ رقم 2. إذا كان هناك حاجة إلى منفذ واحد فقط، يجب لف وحدة الغسل قبل أول استخدام لها بنسبة 90 درجة.

وحدة "iBox" مع وحدة التدفق بالحوض من النوع "Exafill" مع لوازم تصريف الماء وتصريف تدفق المياه. (راجع صفحة 66)

المواصفات الفنية

ضغط التشغيل: الحد الأقصى 1 ميجاباسكال
 ضغط التشغيل الموصى به: 0,1 - 0,5 ميجاباسكال
 ضغط الاختبار: 1,6 ميجاباسكال
 (1 ميجاباسكال = 10 بار = 147 PSI)
 درجة حرارة الماء الساخن: الحد الأقصى 80°C
 درجة الحرارة الموصى بها للماء الساخن: 65°C
 المسافة المركزية: 3/4G
 الوصلات: الماء البارد جهة اليمين - الماء الساخن جهة اليسار
 معدل تدفق 0,3 ميجاباسكال:

خلاط الدش: 32 لتر / الدقيقة
 ثرموستات: 43 لتر / الدقيقة
 ثرموستات متصل بصمام غلق: 26 لتر / الدقيقة
 ثرموستات متصل بصمامات غلق وتحويل: 26 لتر / الدقيقة
 ثرموستات Highflow: 58 لتر / الدقيقة
 Control: 30 لتر / الدقيقة
 خلاط دش الحمام: 31 لتر / الدقيقة // 24 لتر / الدقيقة
 خلاط دش الحمام بمجموعة أمان مدمجة: 25 لتر / الدقيقة // 24 لتر / الدقيقة

يتم استخدام الجسم الرئيسي ذي الدوران المتماثل للوحدة "iBox" في جميع أنحاء العالم سواء بصورة أفقية أو رأسية. إلا أنه لا يمكن القيام بالتركيب إلا بصورة رأسية في هذه الحالة إلا في حالة تركيب لوازم الحوض باستخدام تركيبية الأمان. احرص دوماً على تركيب iBox فوق حوض الاستحمام (البانيو). إذا تعرضت أجزاء من iBox للكسر، فربما يتسبب ذلك في تسرب المياه في كل مكان!

تعد وحدة "iBox" ملائمة لتركيب حوض الاستحمام أو الدش. وفي حالة استخدام خلاط بالحوض بصنوبر واحد فقط / ثرموستات متصل بصمام غلق وتحويل، يفضل استخدام الصرف السفلي. إذا كانت هناك حاجة لصرف واحد فقط، يمكن حسب الرغبة اختيار الصرف العلوي أو السفلي. يجب سد المنفذ غير المستخدم عن طريق سداة. يجب أن يكون تيار الماء الساخن والماء البارد متعادلين في الضغط.

قم بتركيب الجسم الرئيسي للوحدة بصورة ملائمة بحيث توجد وصلة المياه الساخنة في الجانب الأيسر ووصلة المياه الباردة في الجانب الأيمن.

عمق التركيب: من 80 مم حتى 108 مم.

وصلة إطالة 25 مم: #13595000

طقم الملحقات 22 مم (عندما لا يكون الجدار عميقاً بما يكفي): #13596XXX / #13597XXX / #13593000 / #15597000 / #97407XXX / #19427000 / #15597000 / #13601000 / #98860000

يمكن تركيب الجسم الرئيسي للوحدة وفقاً لظروف البناء، انظر أمثلة التركيب صفحتي 62 و 63.

A التركيب على حائط مباشر

B التركيب على الحائط المباشر بجوابط تركيب قابلة للضبط طولها 10 مم.

C التركيب على نظام حمامات.

D التركيب على حائط مجوف

E التركيب على حائط من الطوب

F التركيب باستخدام طقم التثبيت #96615000

يوجد بدءاً من صفحة 68 أمثلة للتركيب بمقاسات وطرق عمل بعض الوصلات. يوجد شرح للرموز المستخدمة على الصفحات 67.



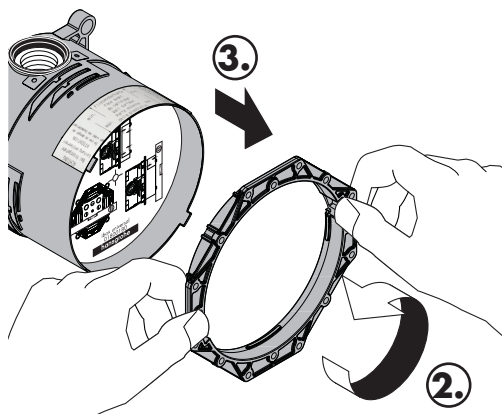
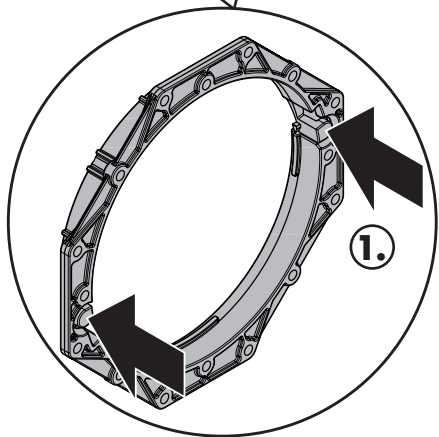
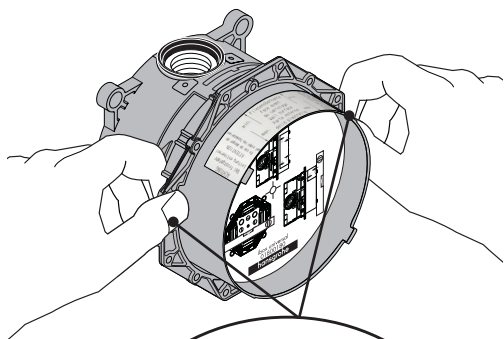
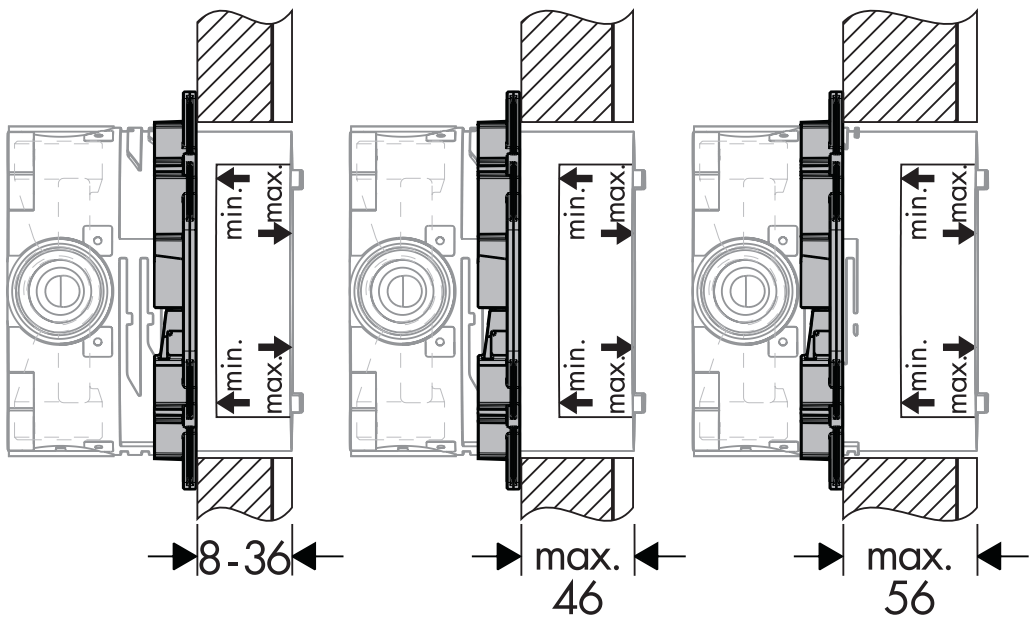

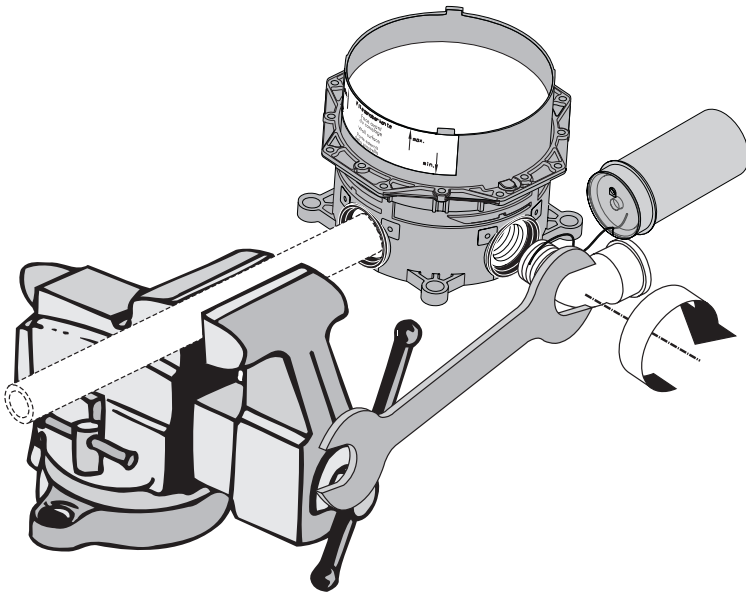
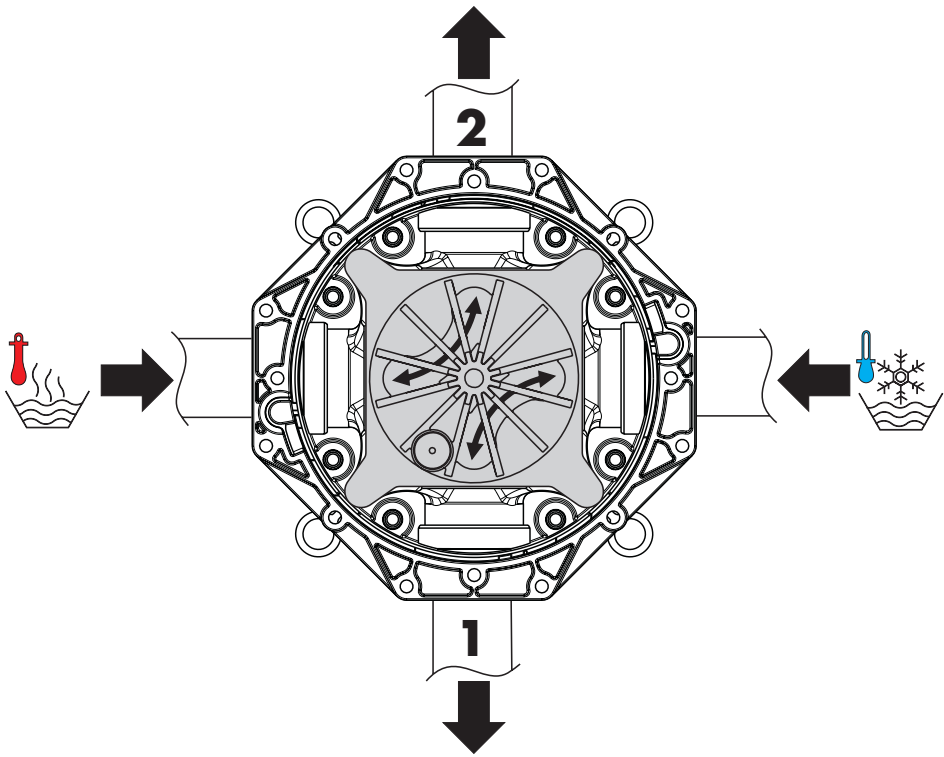

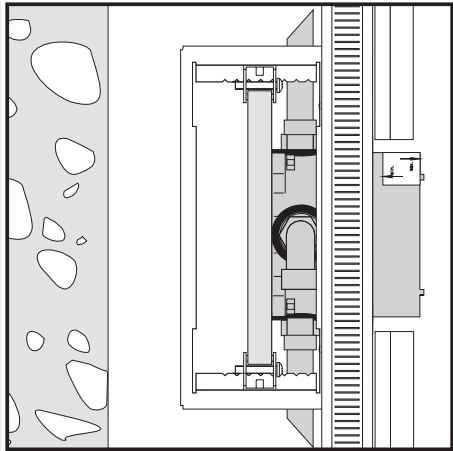
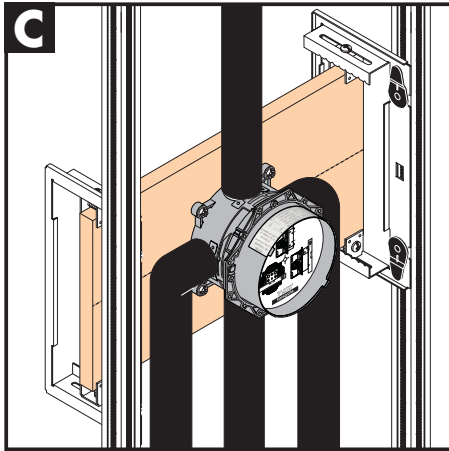
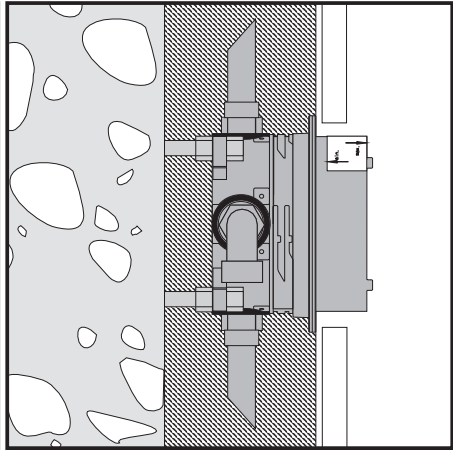
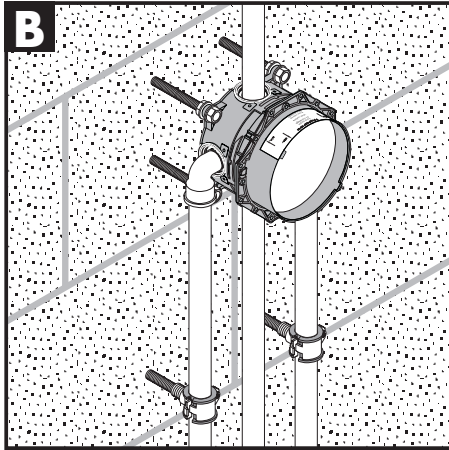
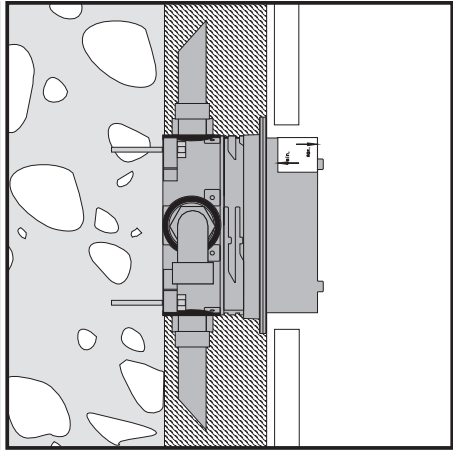
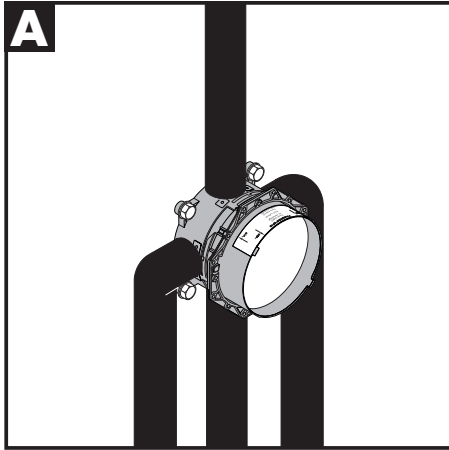

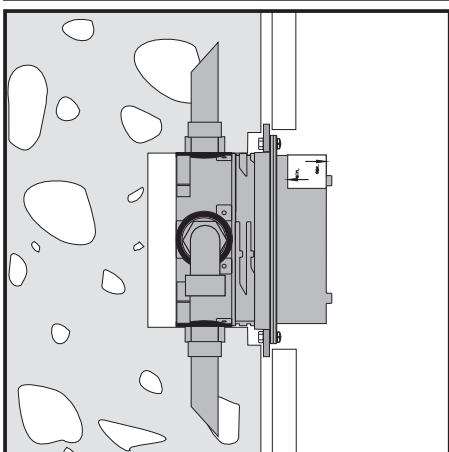
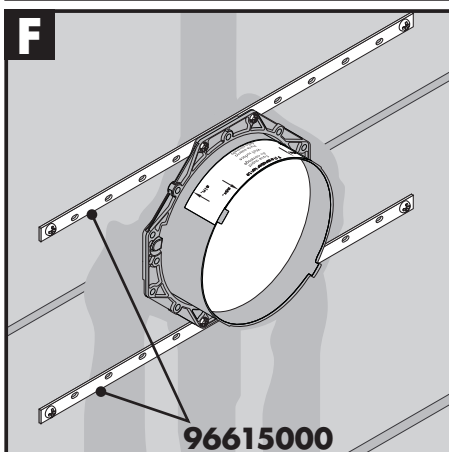
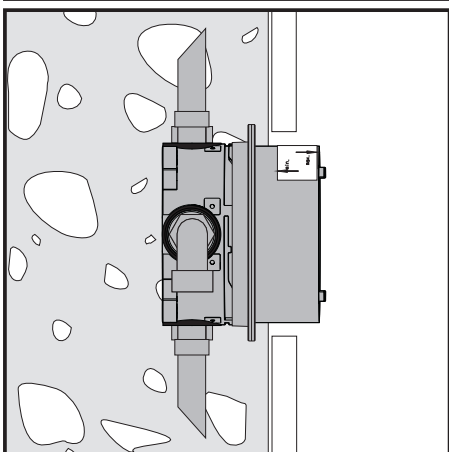
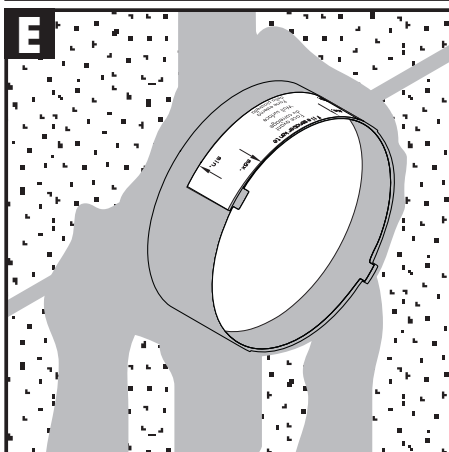
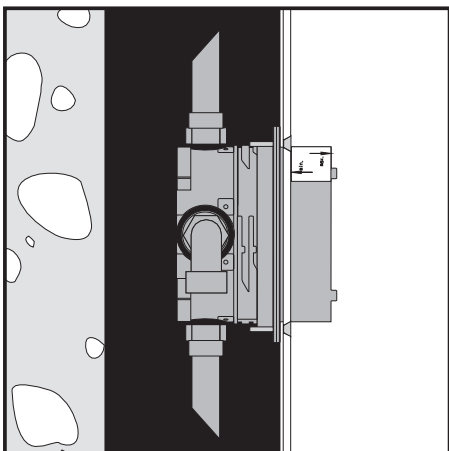
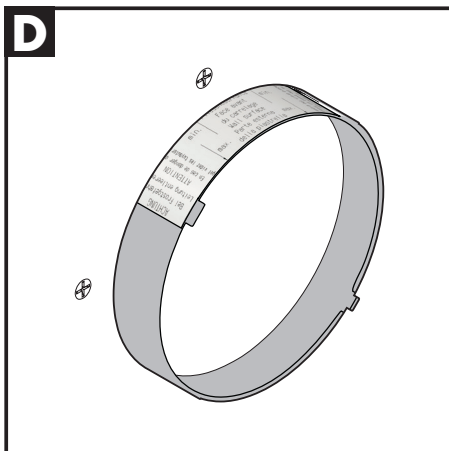

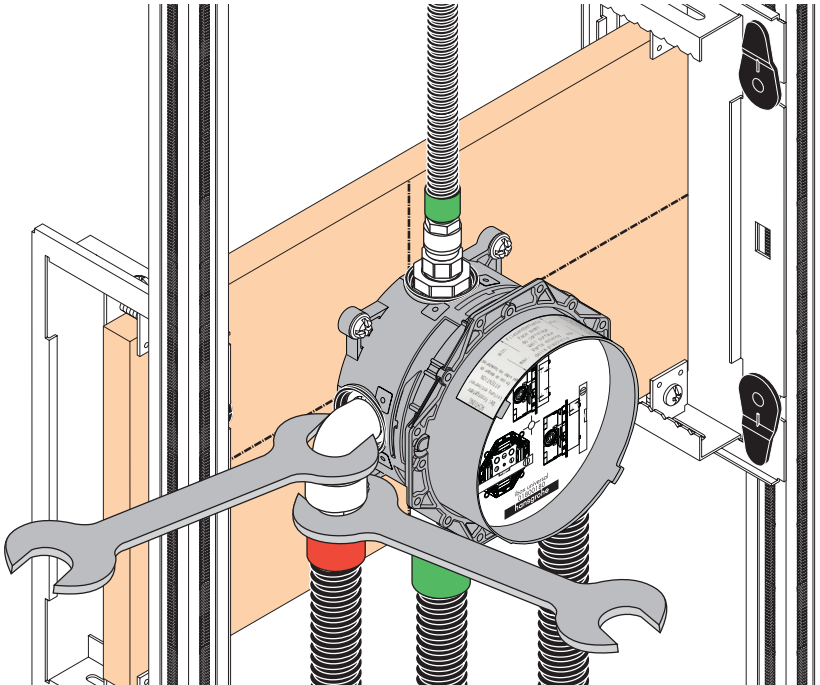
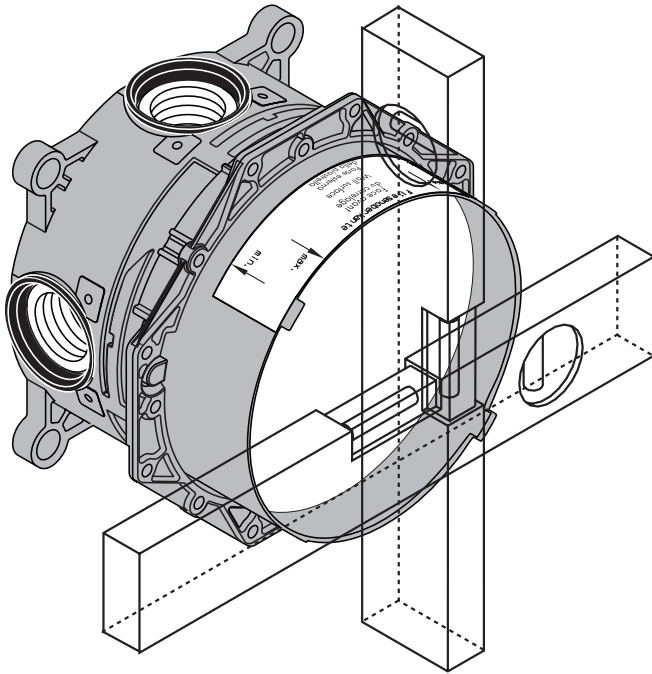

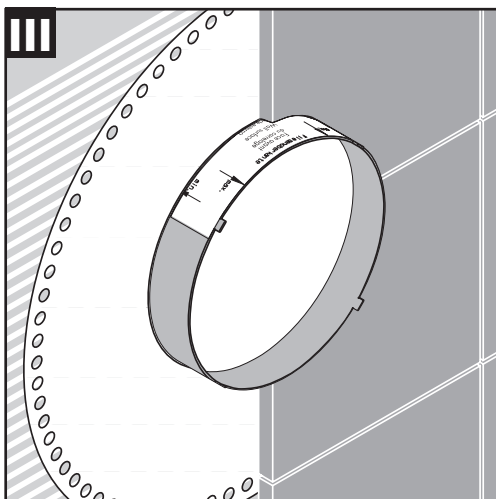
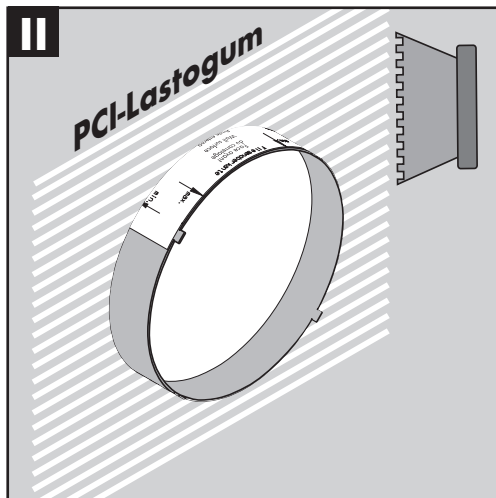
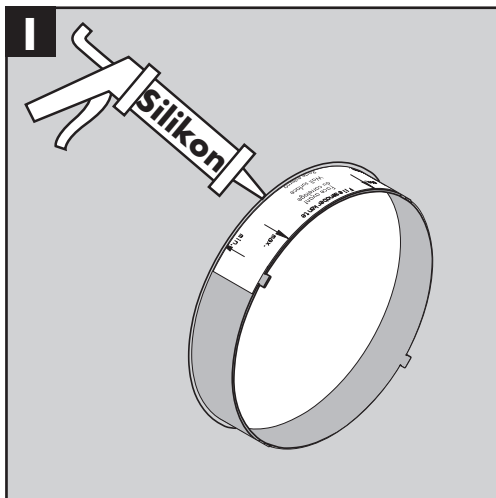

Prüfzeichen / Classification acoustique et débit / Test certificate / Segno di verifica / Marca de verificaci3n / Keurmerk / Godkendelse / Marca de controlo / Znak jakości / Zkušební značka / Osvedčenie o skúške / 检验标记 / Знак технического контроля / Vizsgajel / Koestusmerkki / Testsigill / Bandyto pažyma / Oznaka testiranja / Kontrol isareti / Certificat de testare / Σήμα ελέγχου / Preskusni znak / Kontrollsertifikaat / Pārbaudes zīme / Ispitni znak / Prøvermerke / Контролен знак / Shenja e kontrollit / شهادة اختبار

DVGW SVGW WRAS KIWA ACS

BP5615 X X X X



iBox universal + Exafill

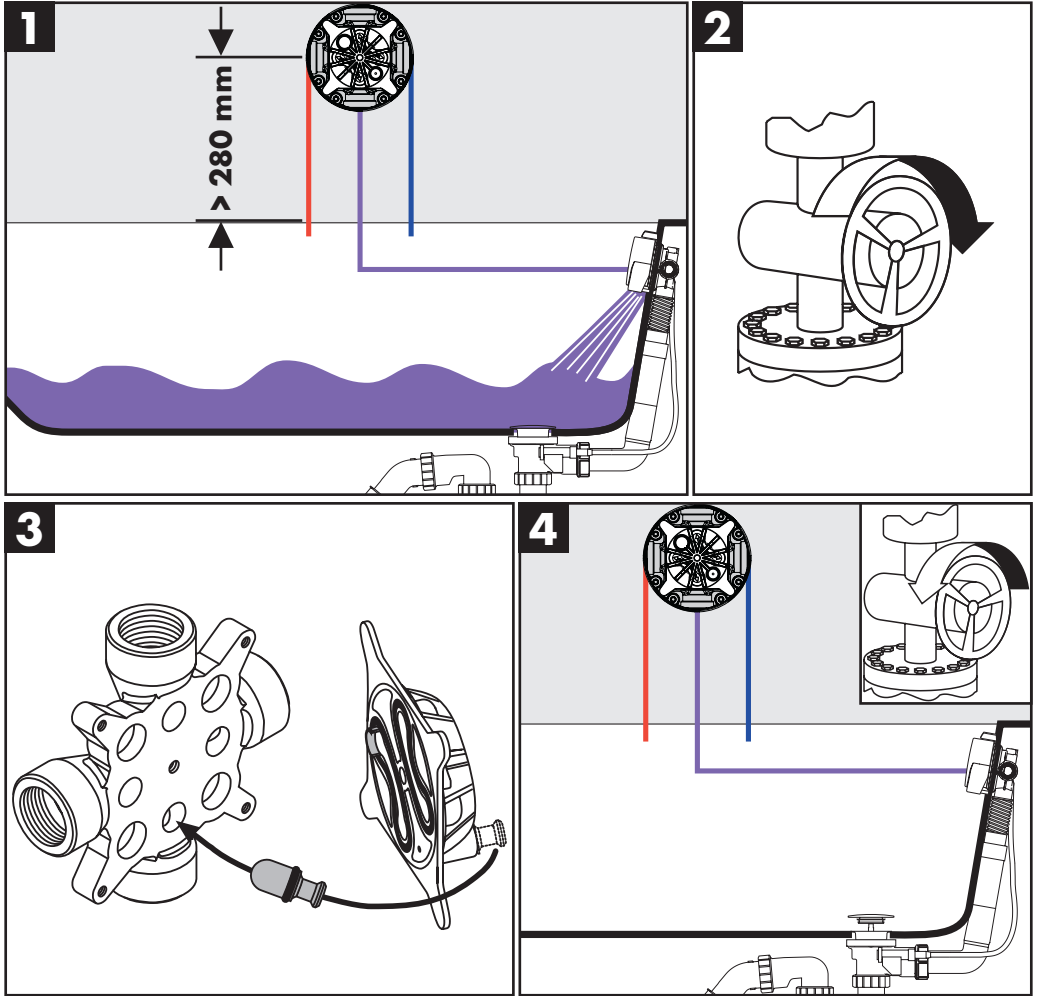
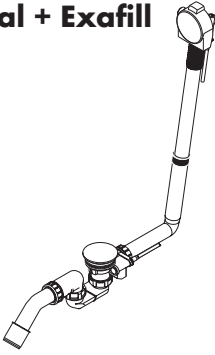
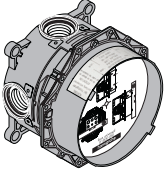

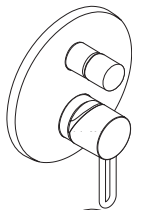

70, 80,
82

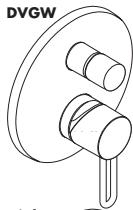

DVGW

68

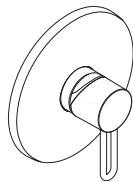

72 - 76,
90

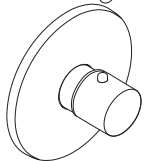

84, 88,
92



High
Flow

94 - 98,
102, 104,
110 - 120

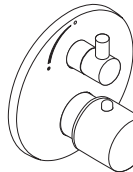

72 - 76,
90

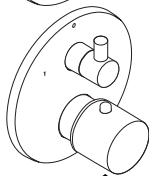

70, 80,
82, 86

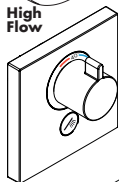

High
Flow

100, 106,
108, 122

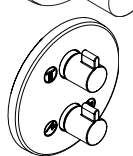

110

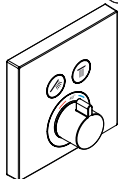

70, 80,
82, 86

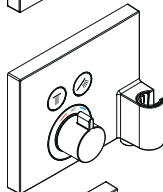

78

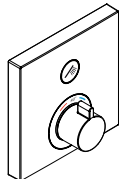

72 - 76

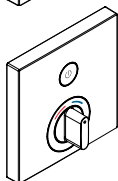

72 - 76

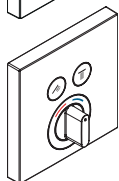

70, 80,
82, 86

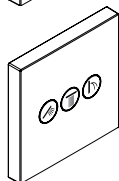

100,
106 - 110,
118 - 122

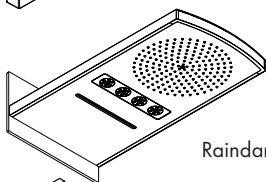

100, 102

Raindance Rainfall 240

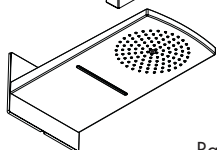

114 - 118

Raindance Rainfall 180

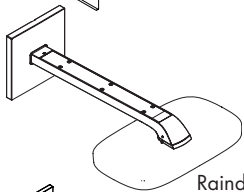

108

Raindance Select E 300

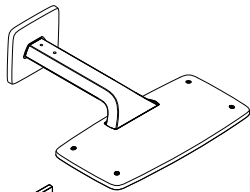

110, 112

Raindance E 420

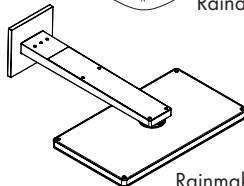

120

Rainmaker Select 460 2jet

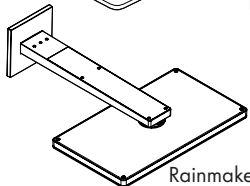

122

Rainmaker Select 460 3jet

DVGW

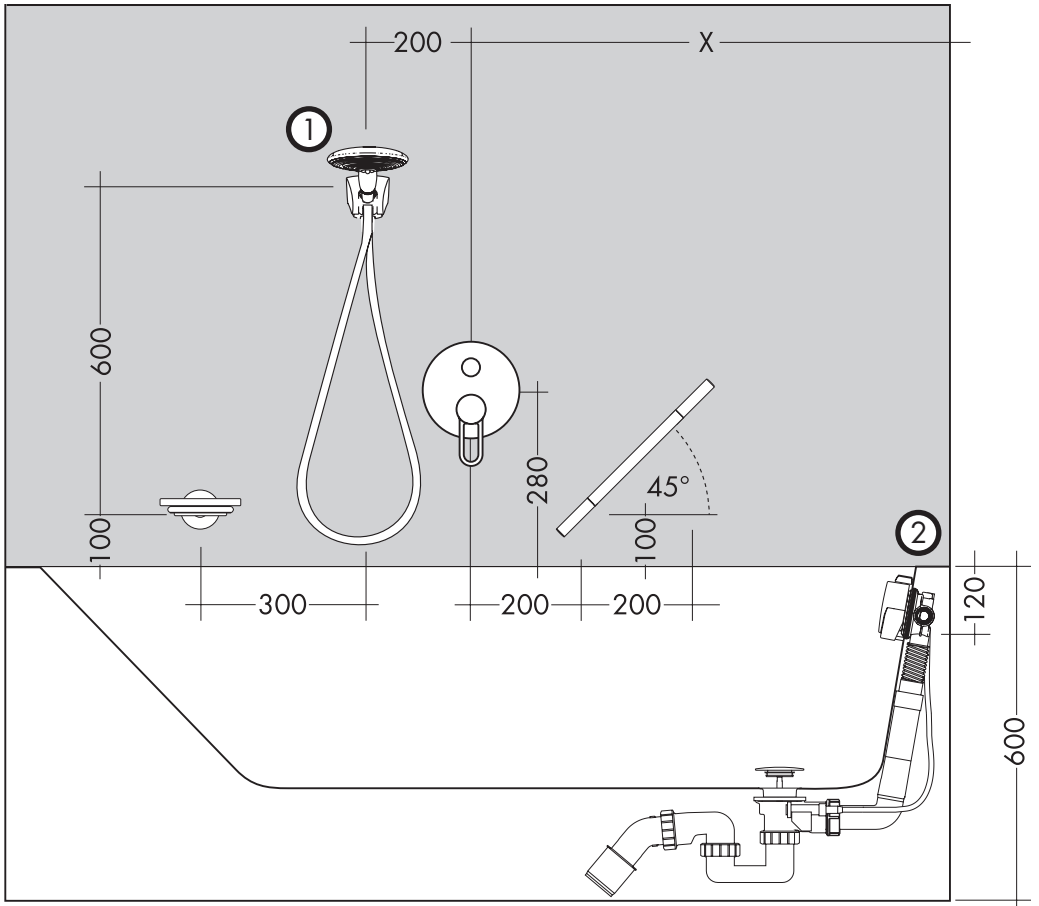
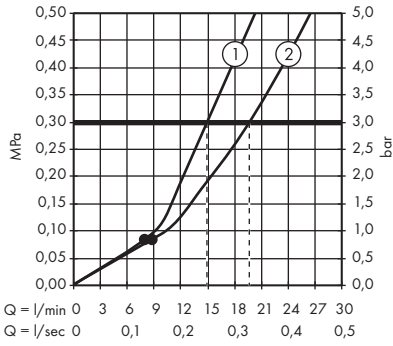
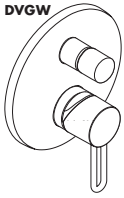

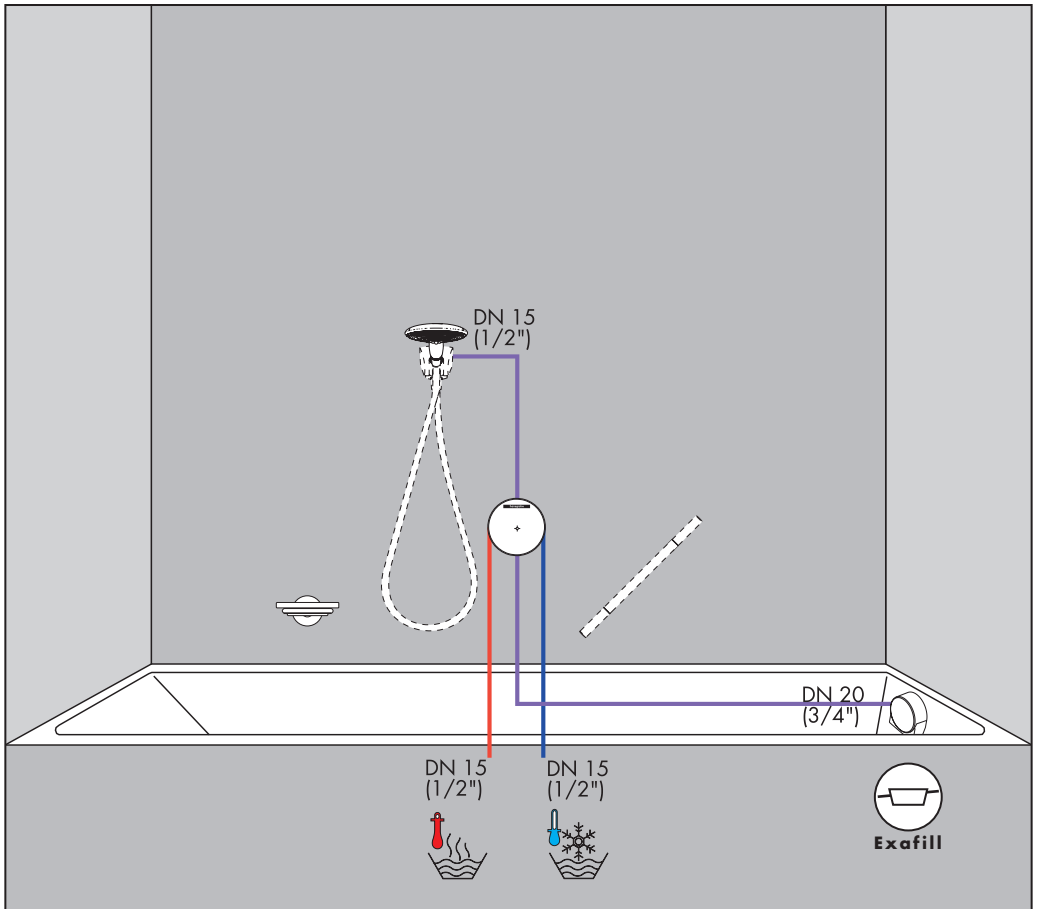

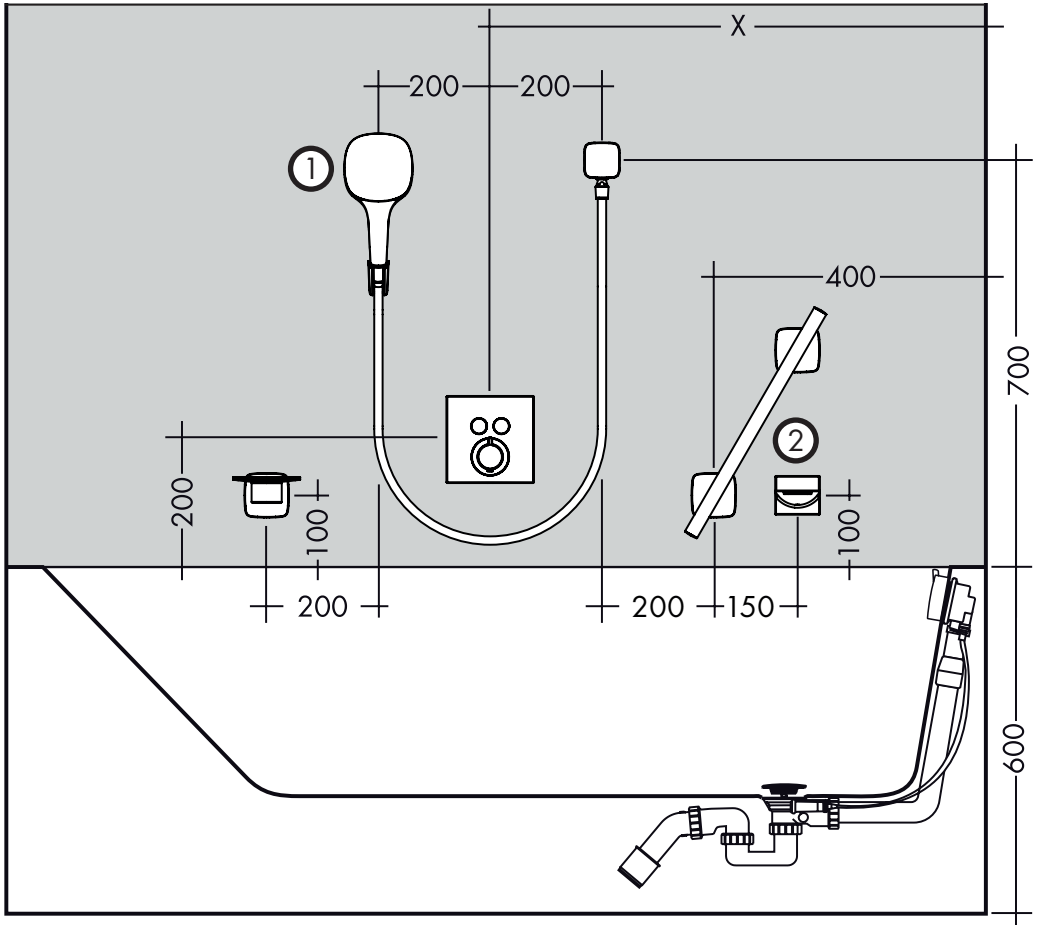
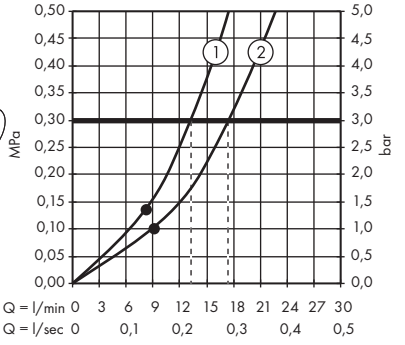
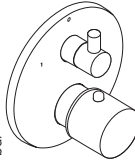
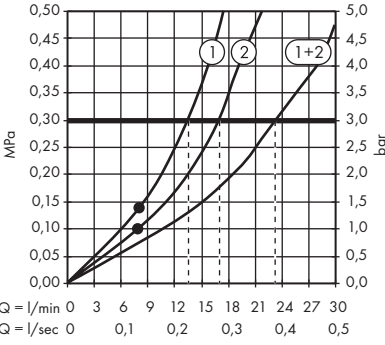
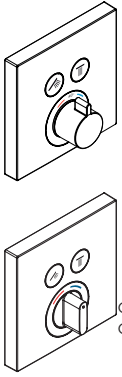

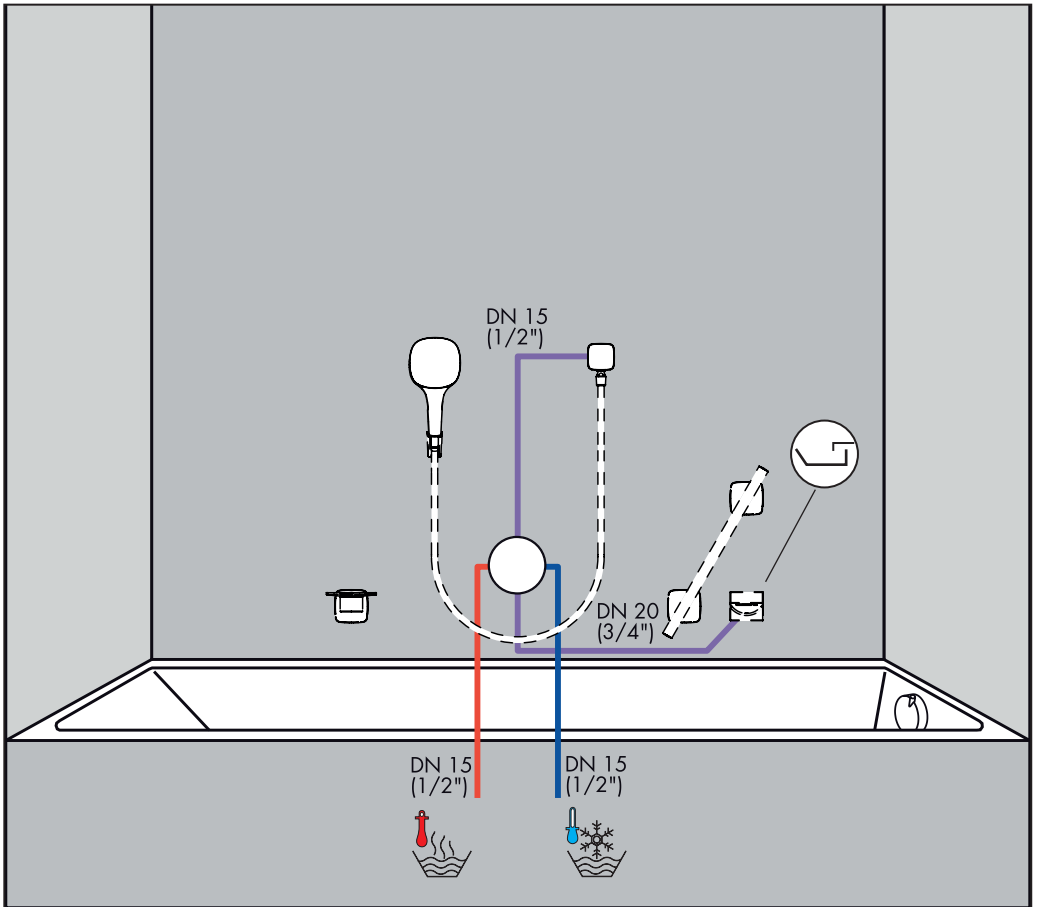
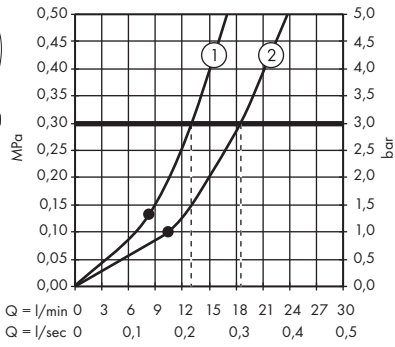
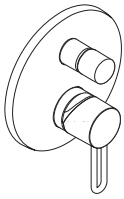

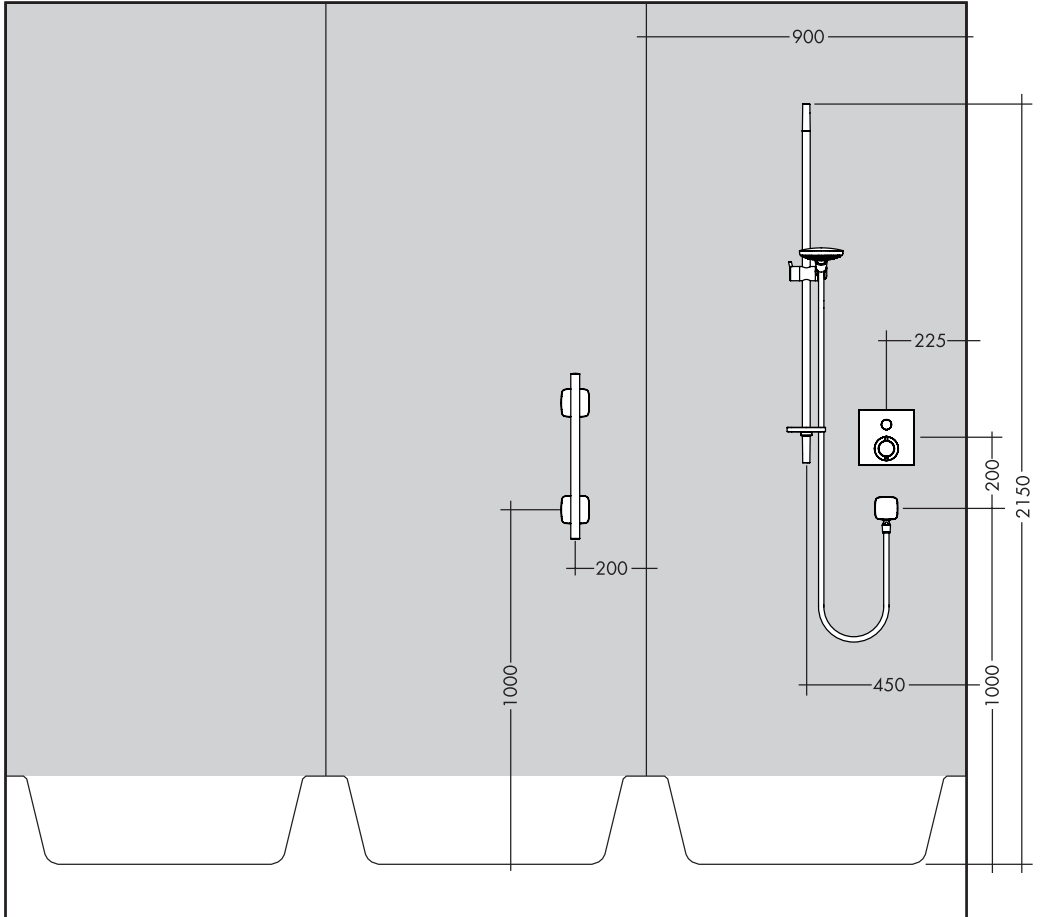
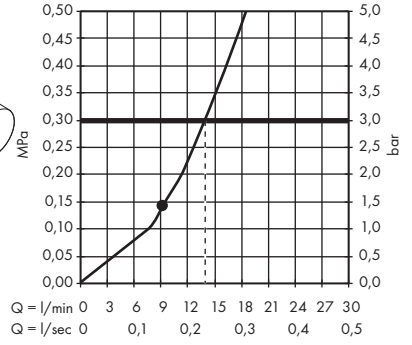
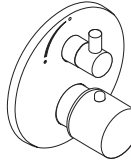
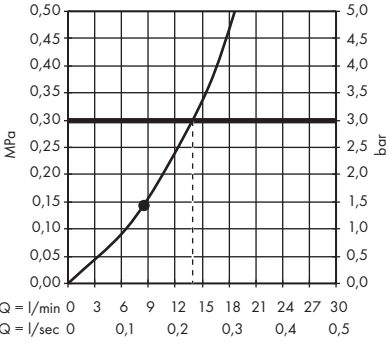
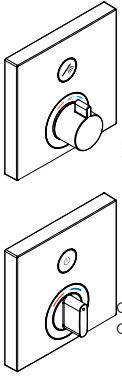

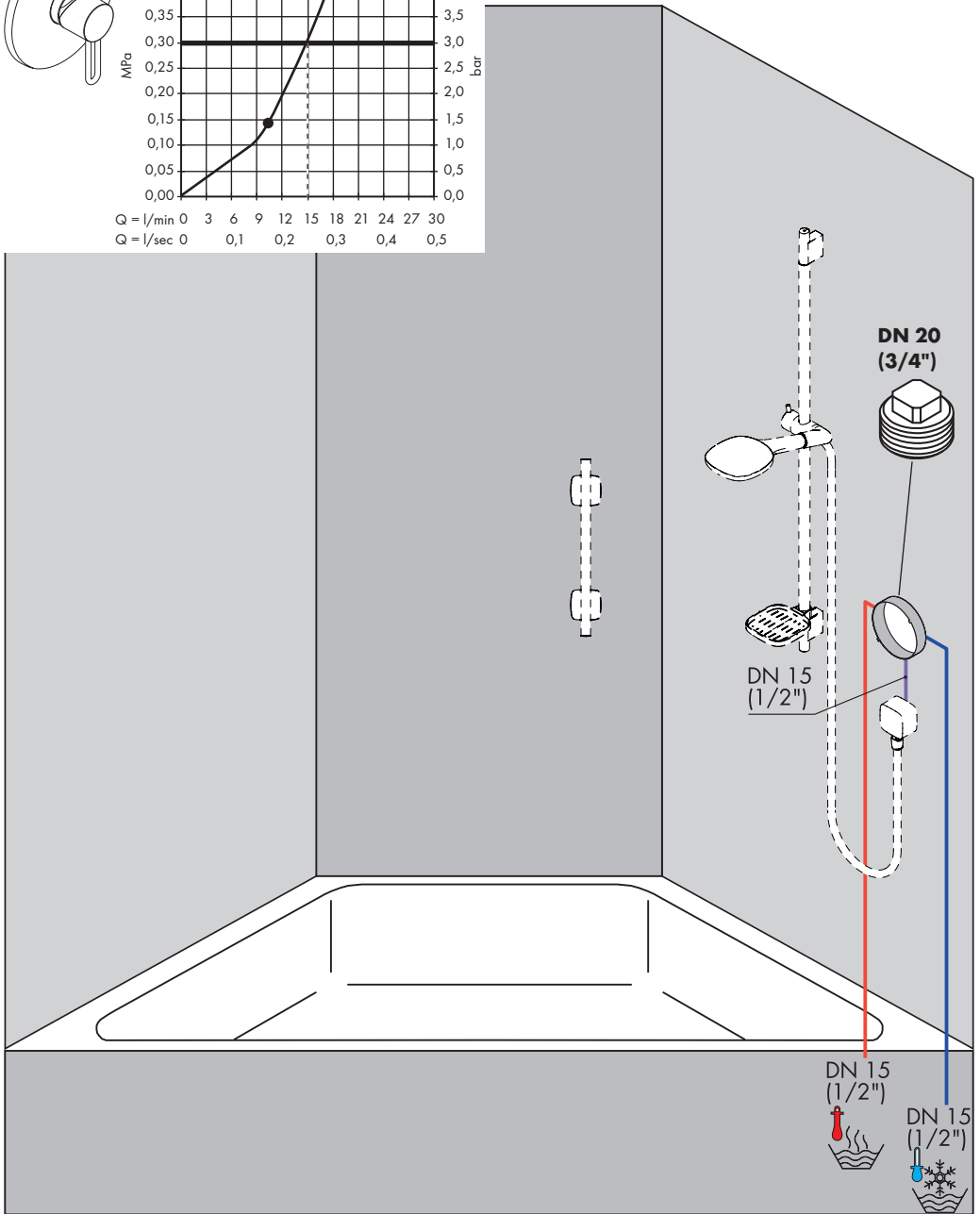
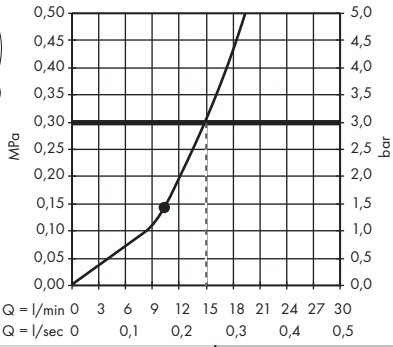
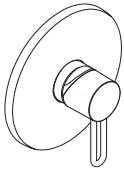

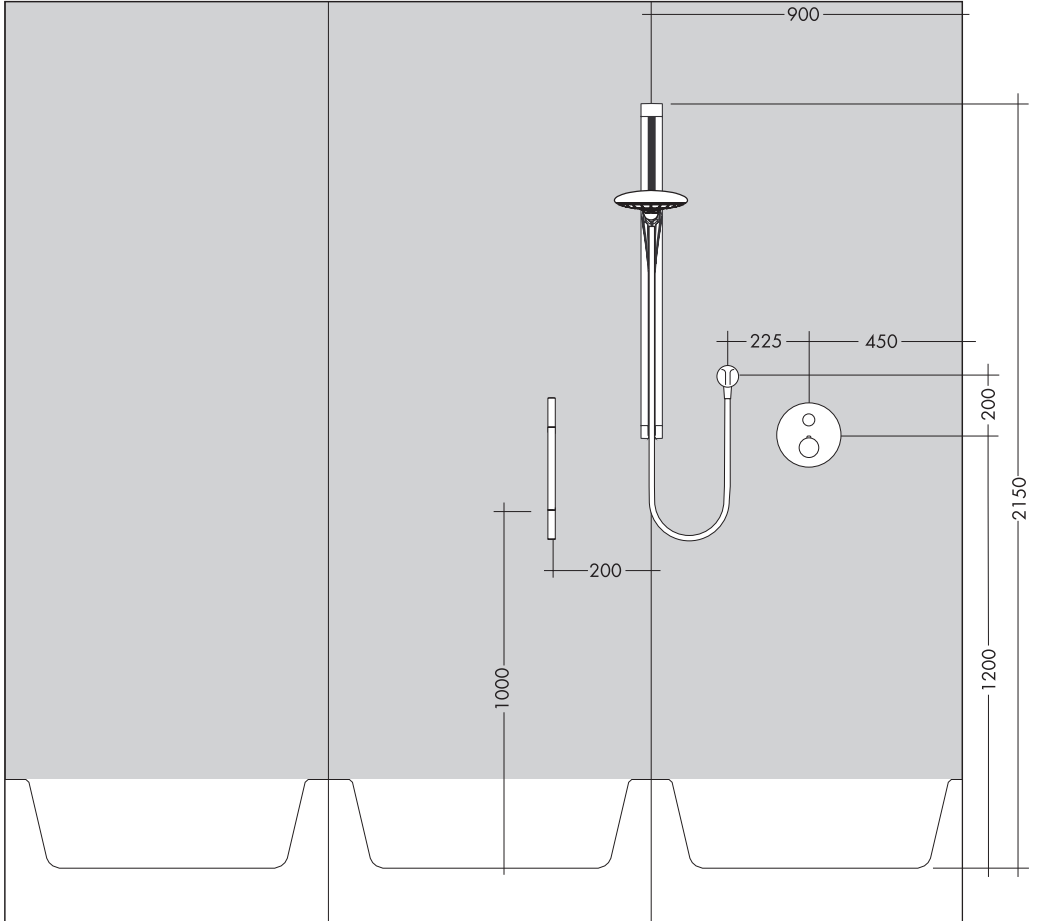
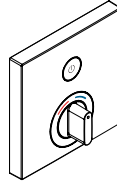
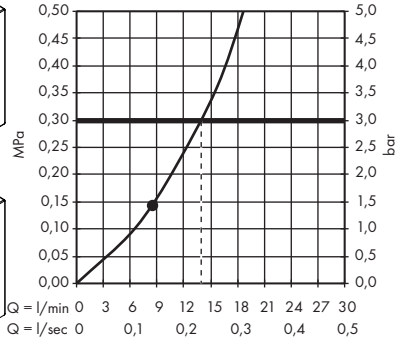
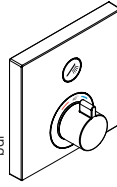
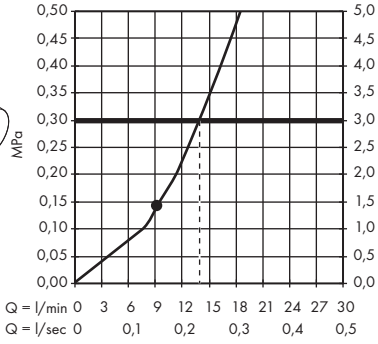
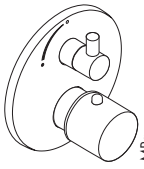

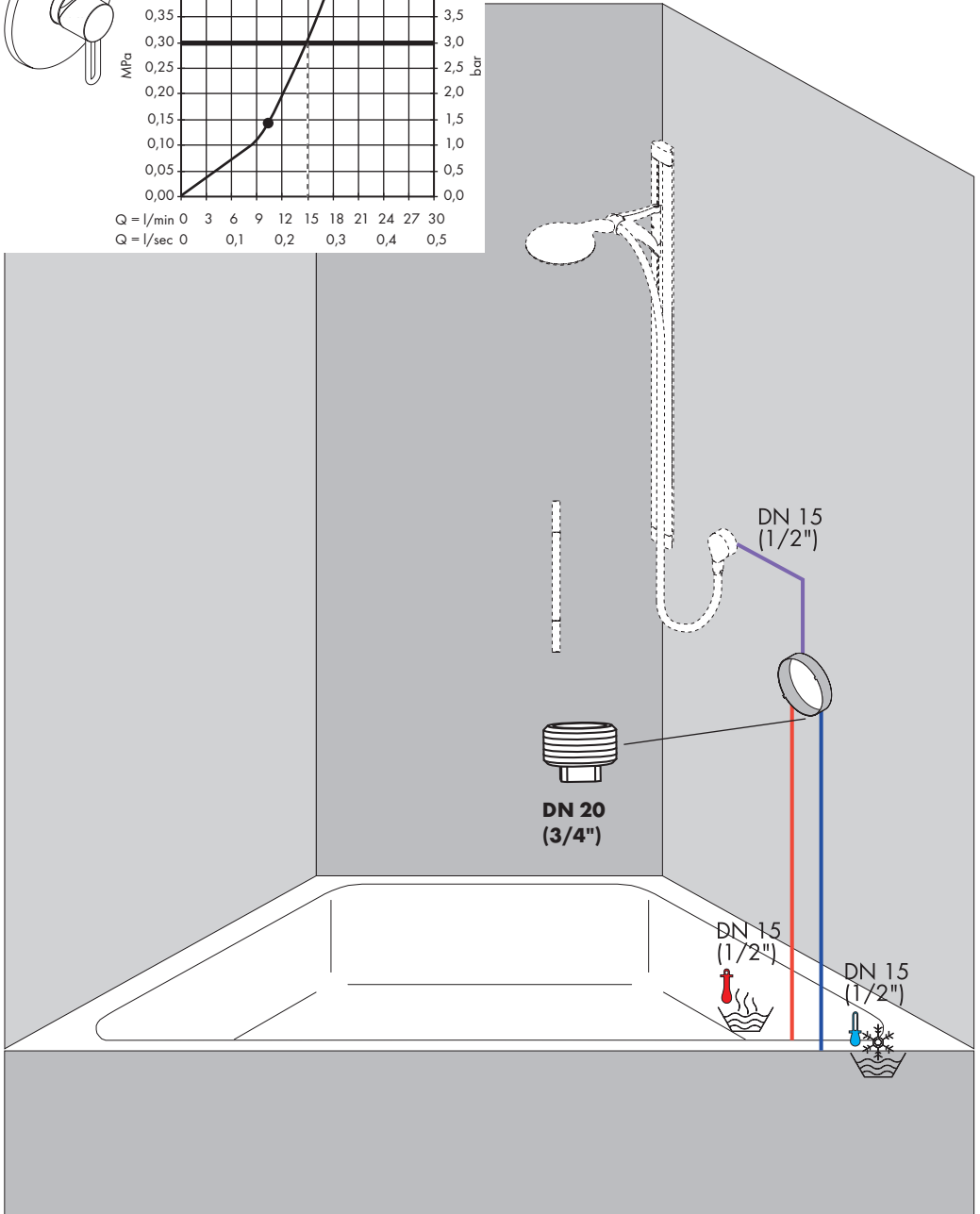
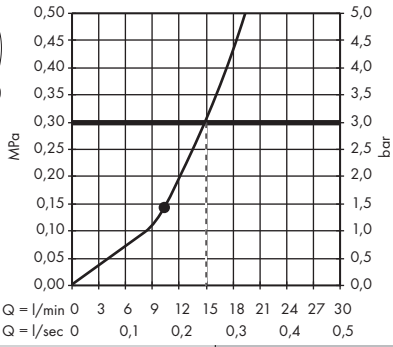
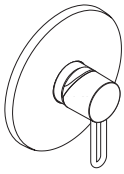

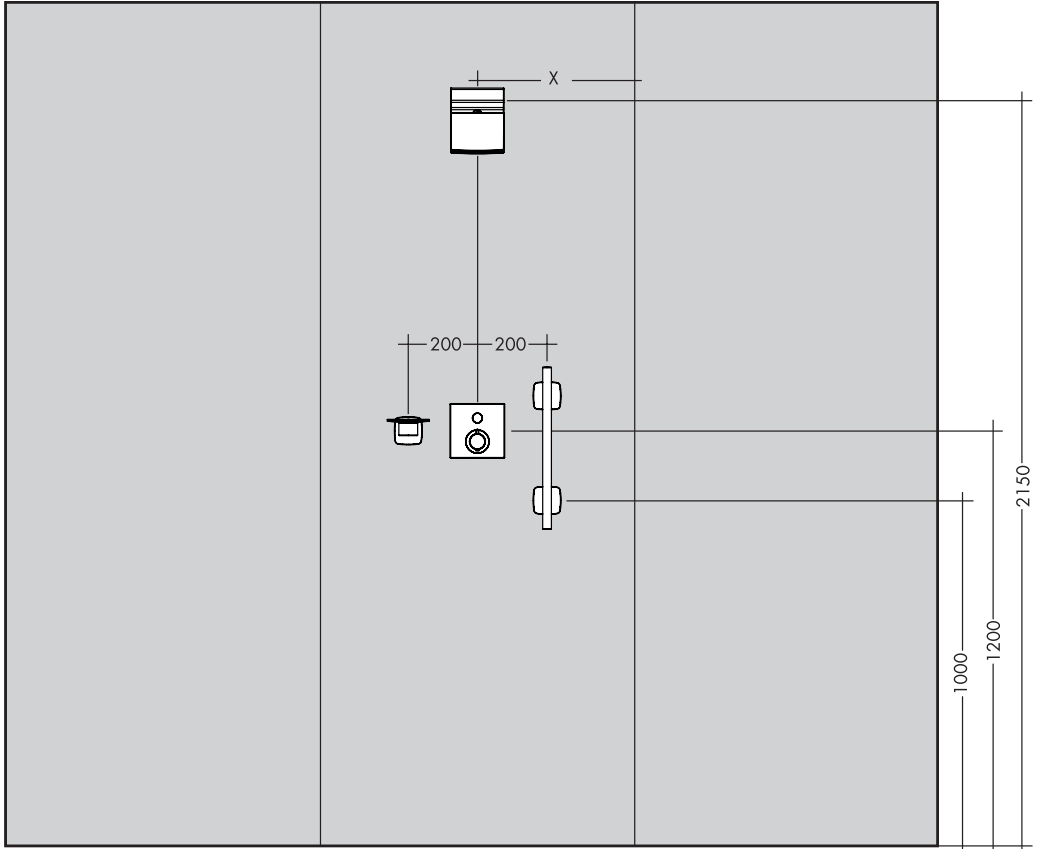
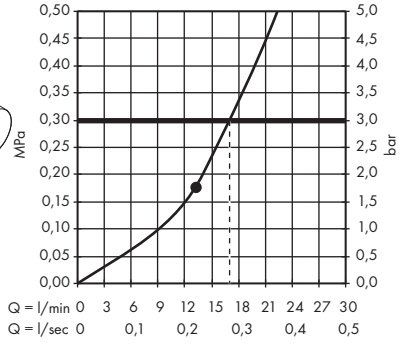
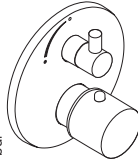
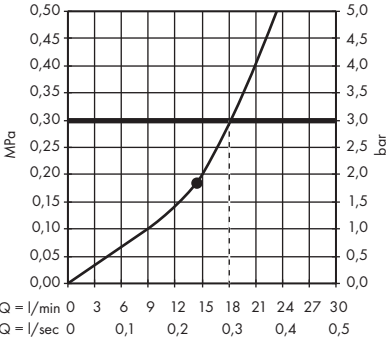
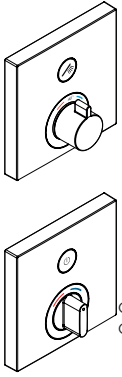

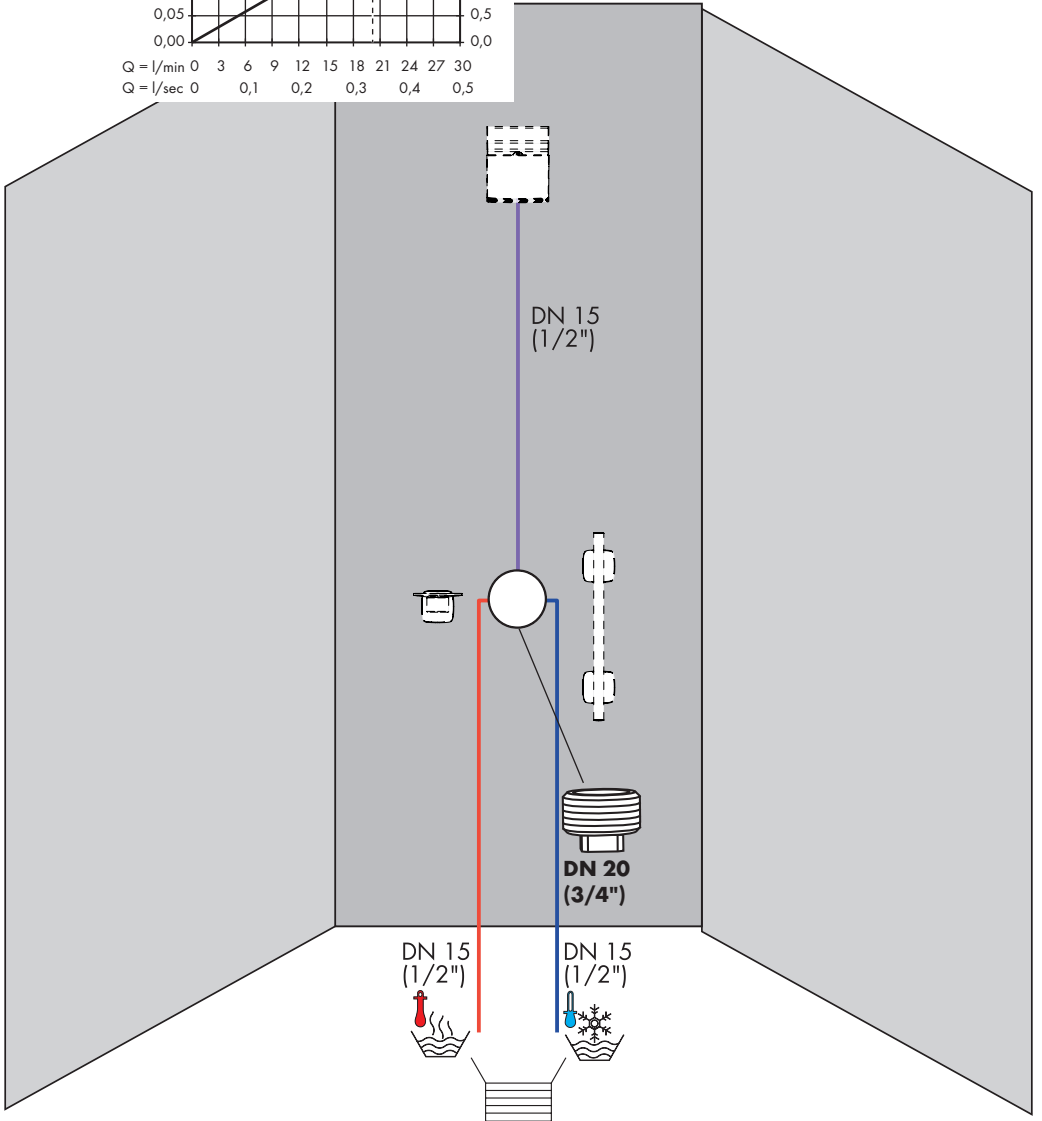
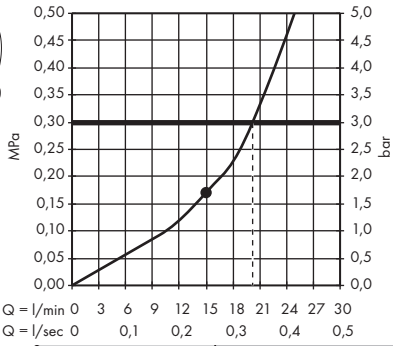
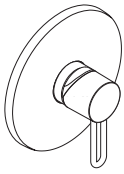

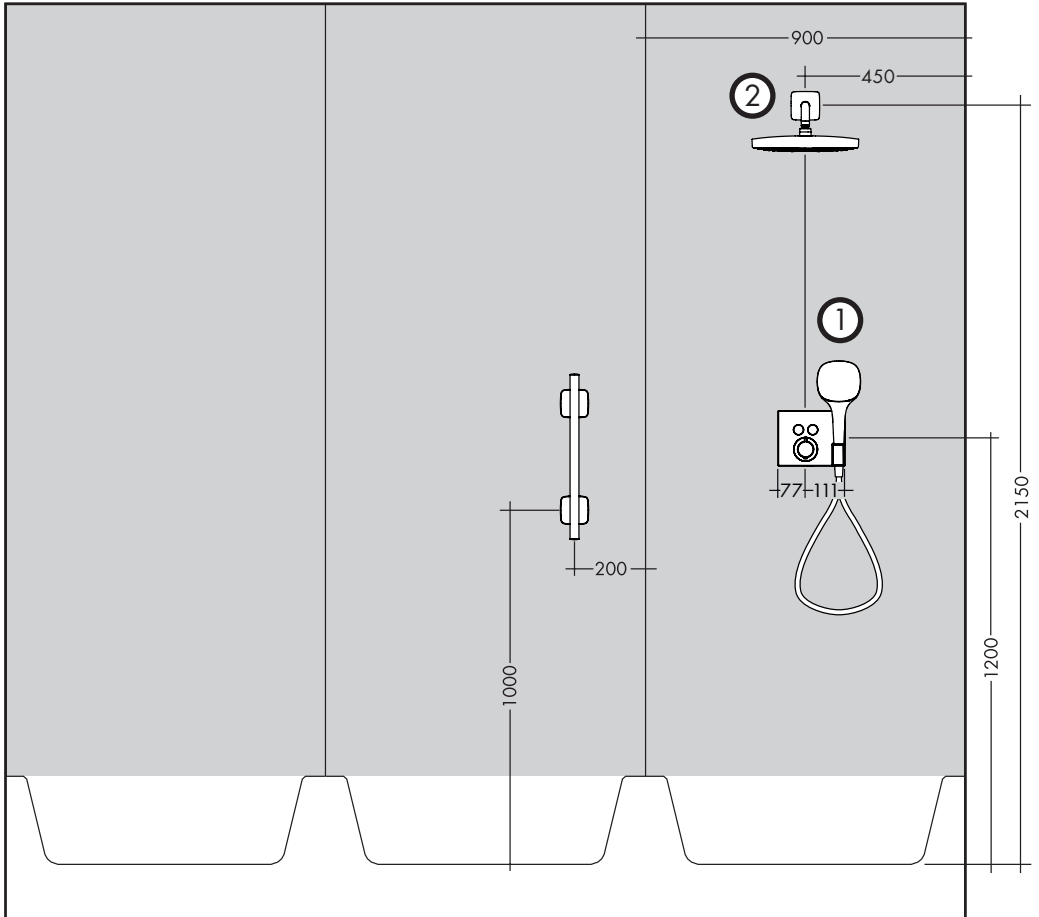
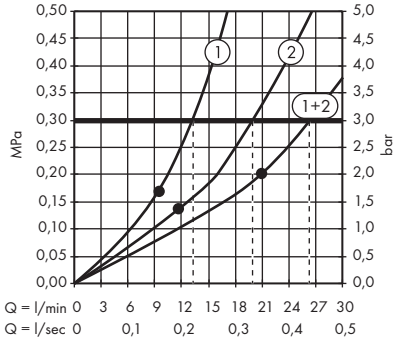
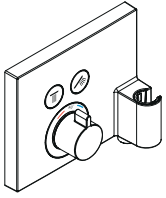

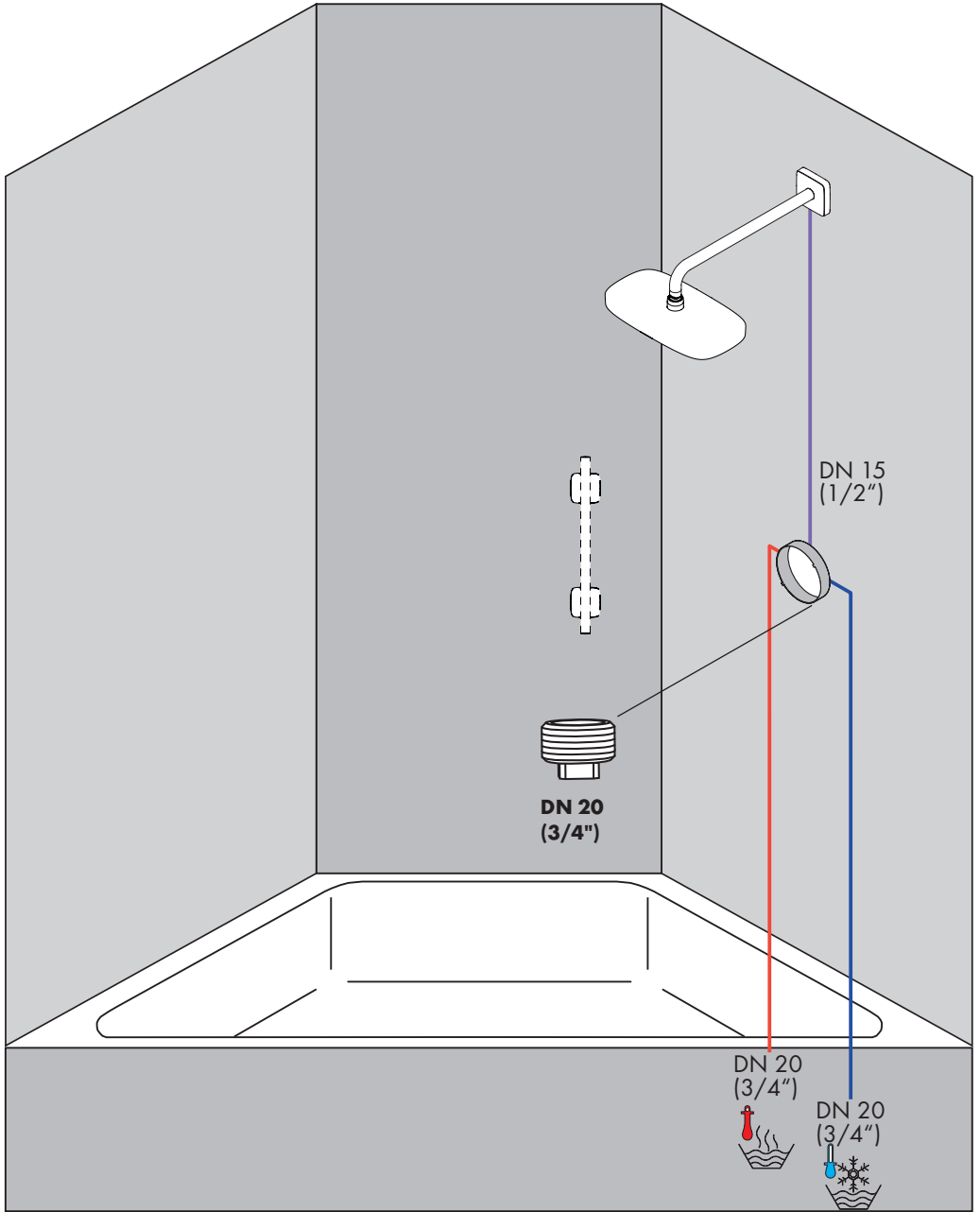

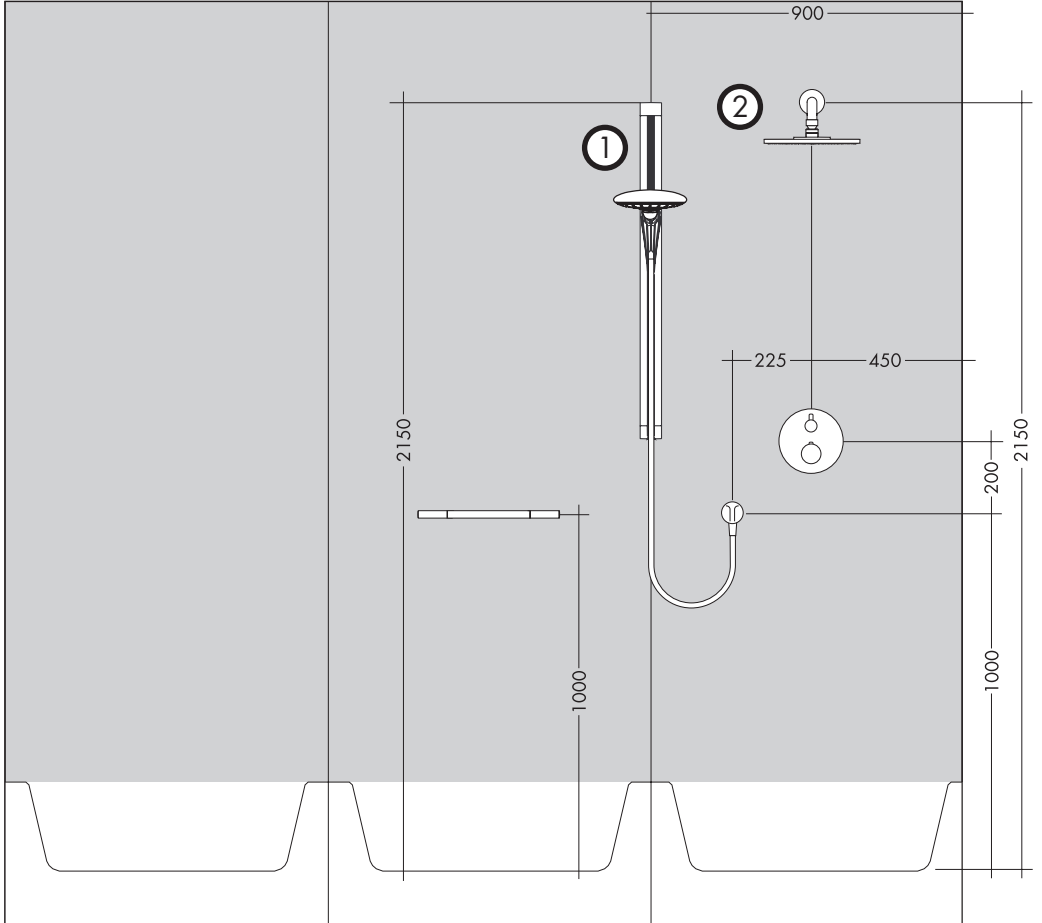
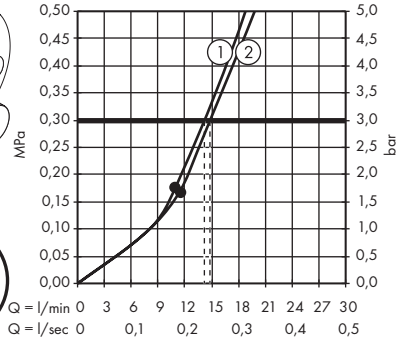
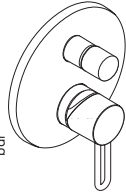
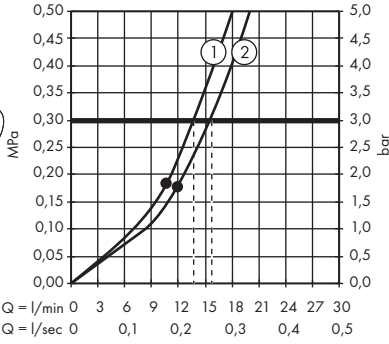
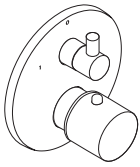

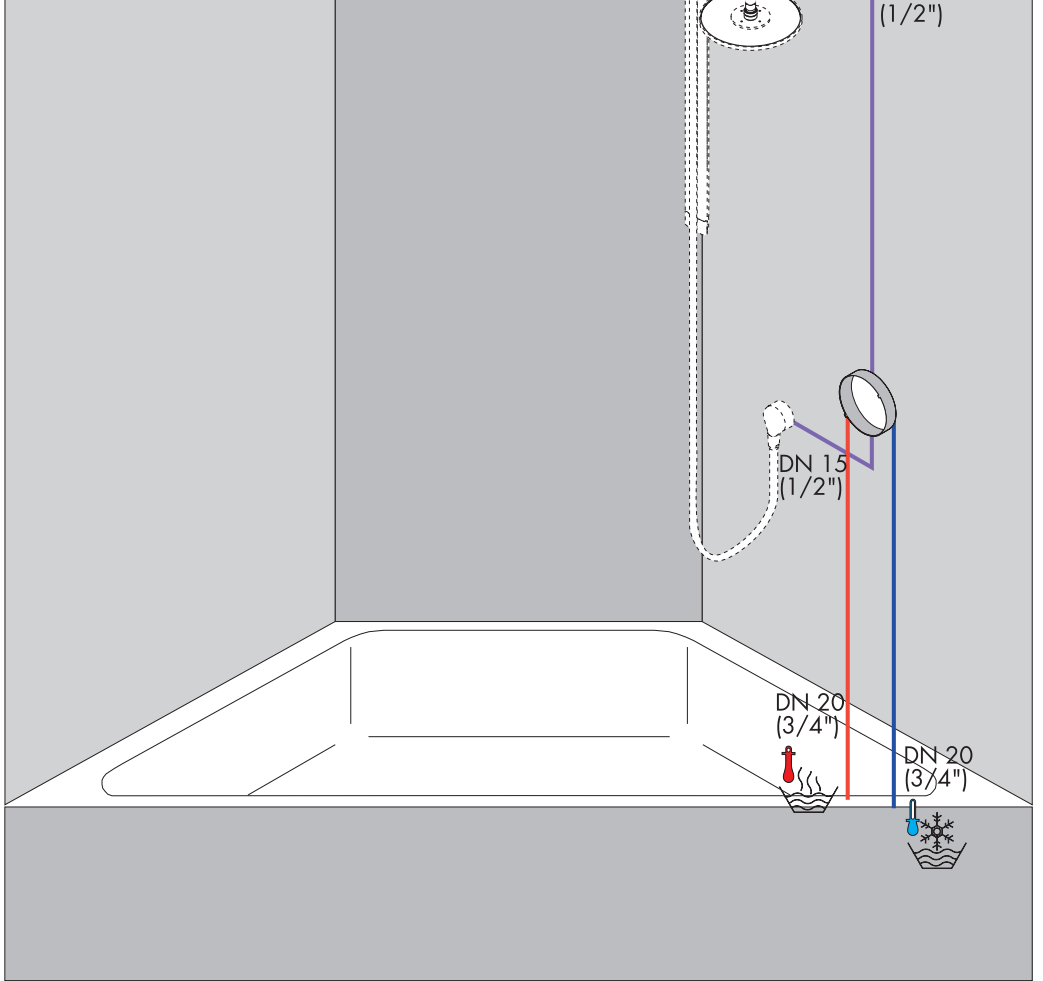
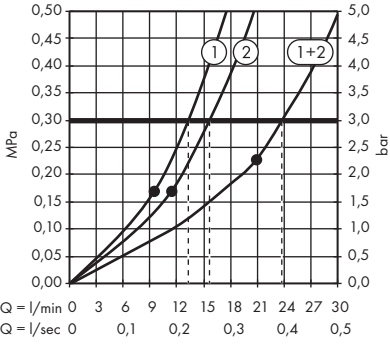
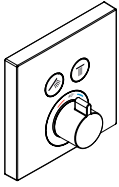

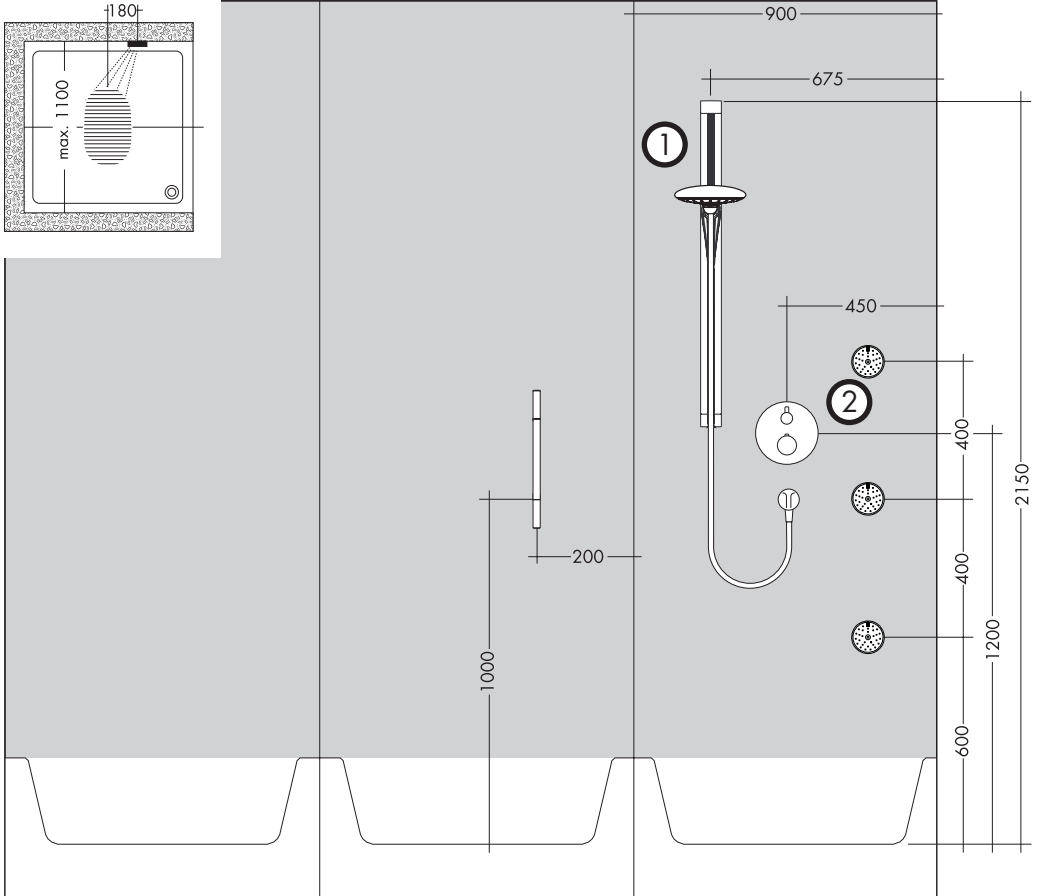
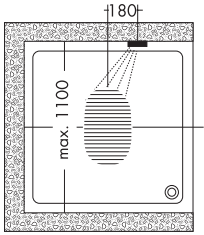
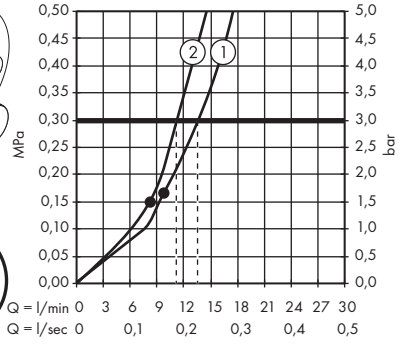
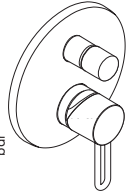
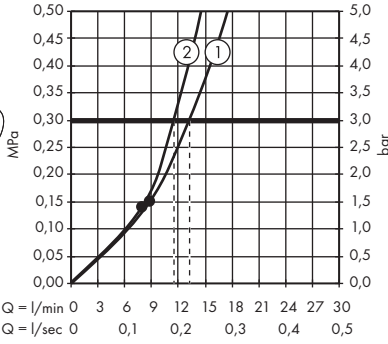
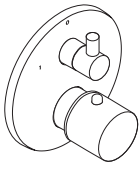

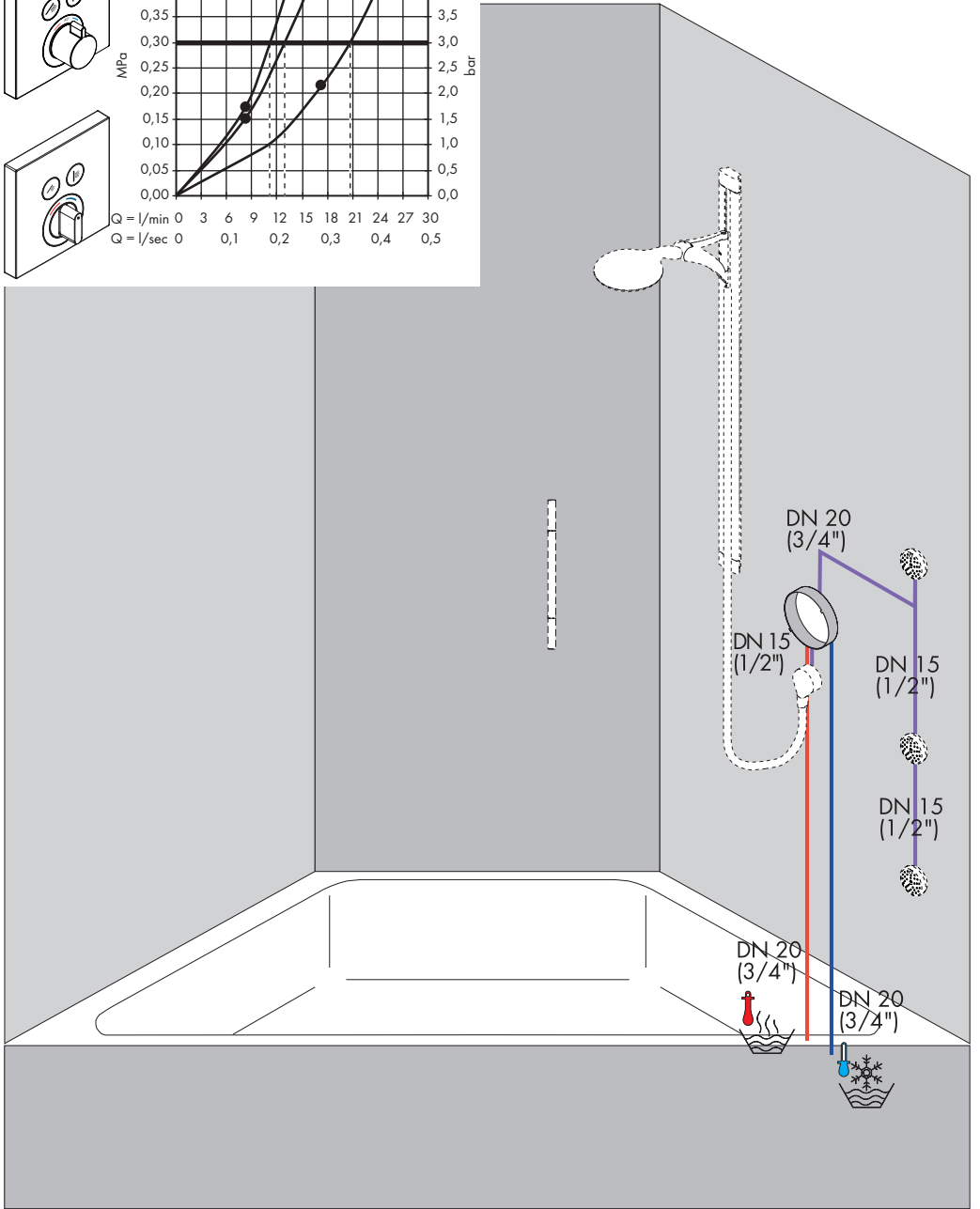
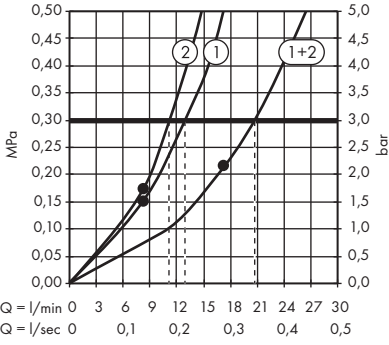
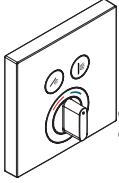
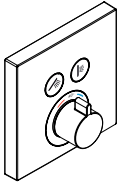

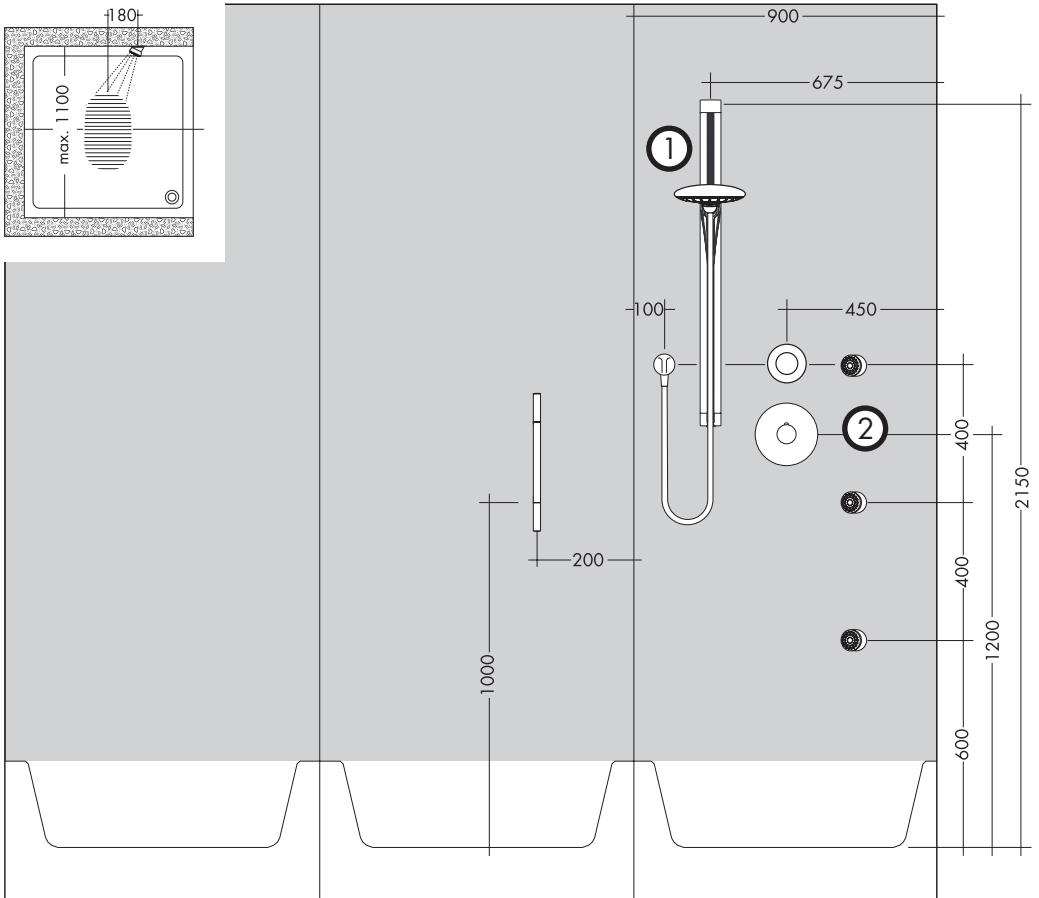
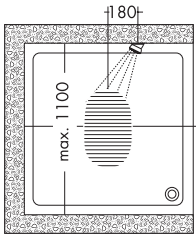
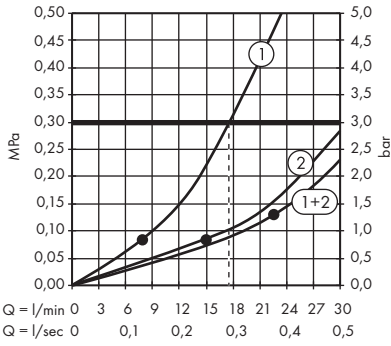
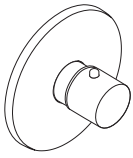

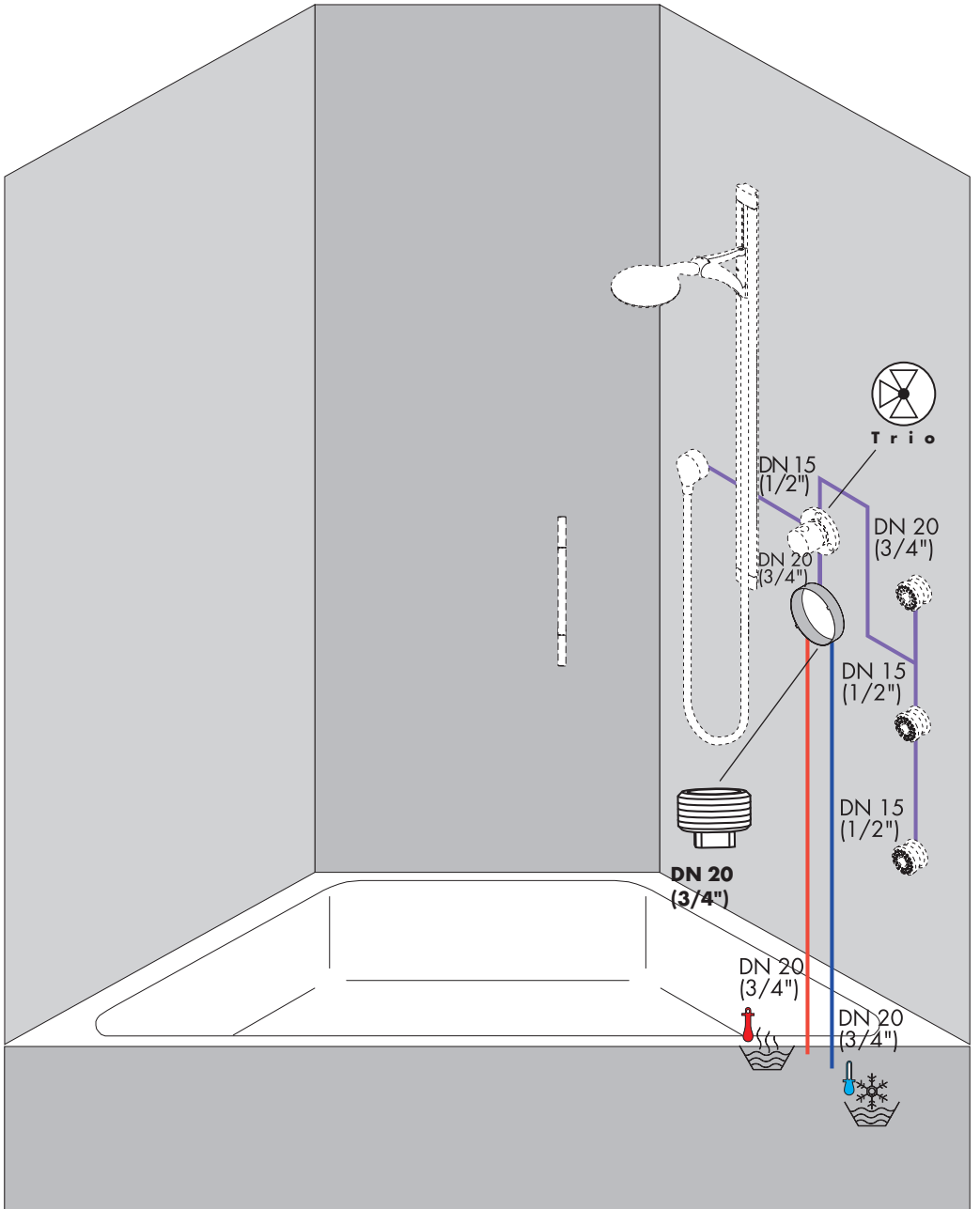

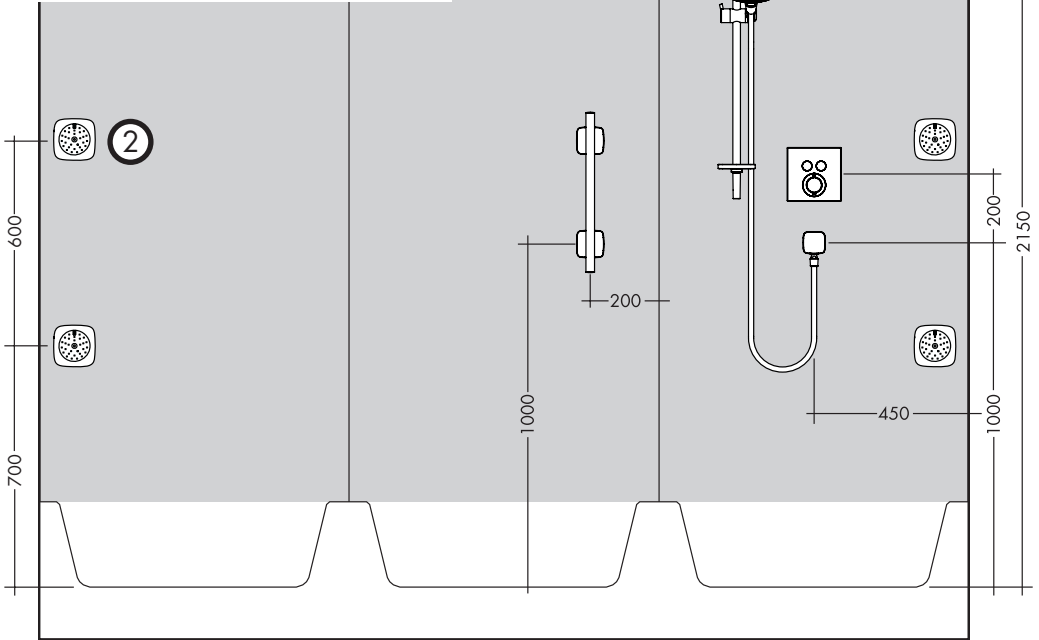
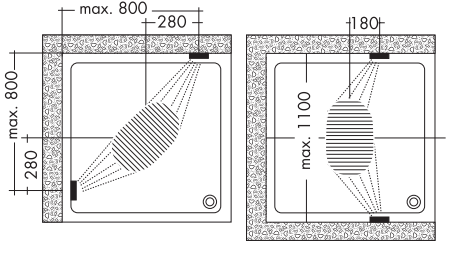
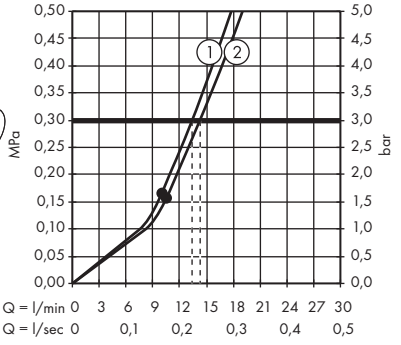
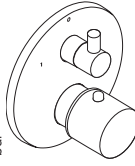
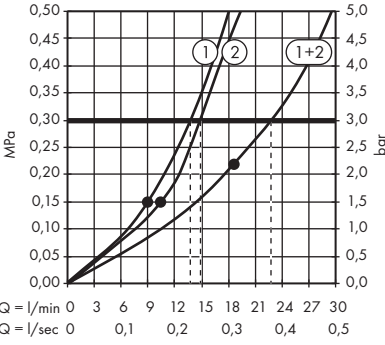
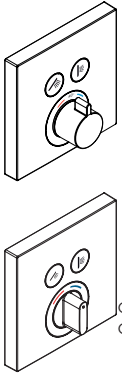

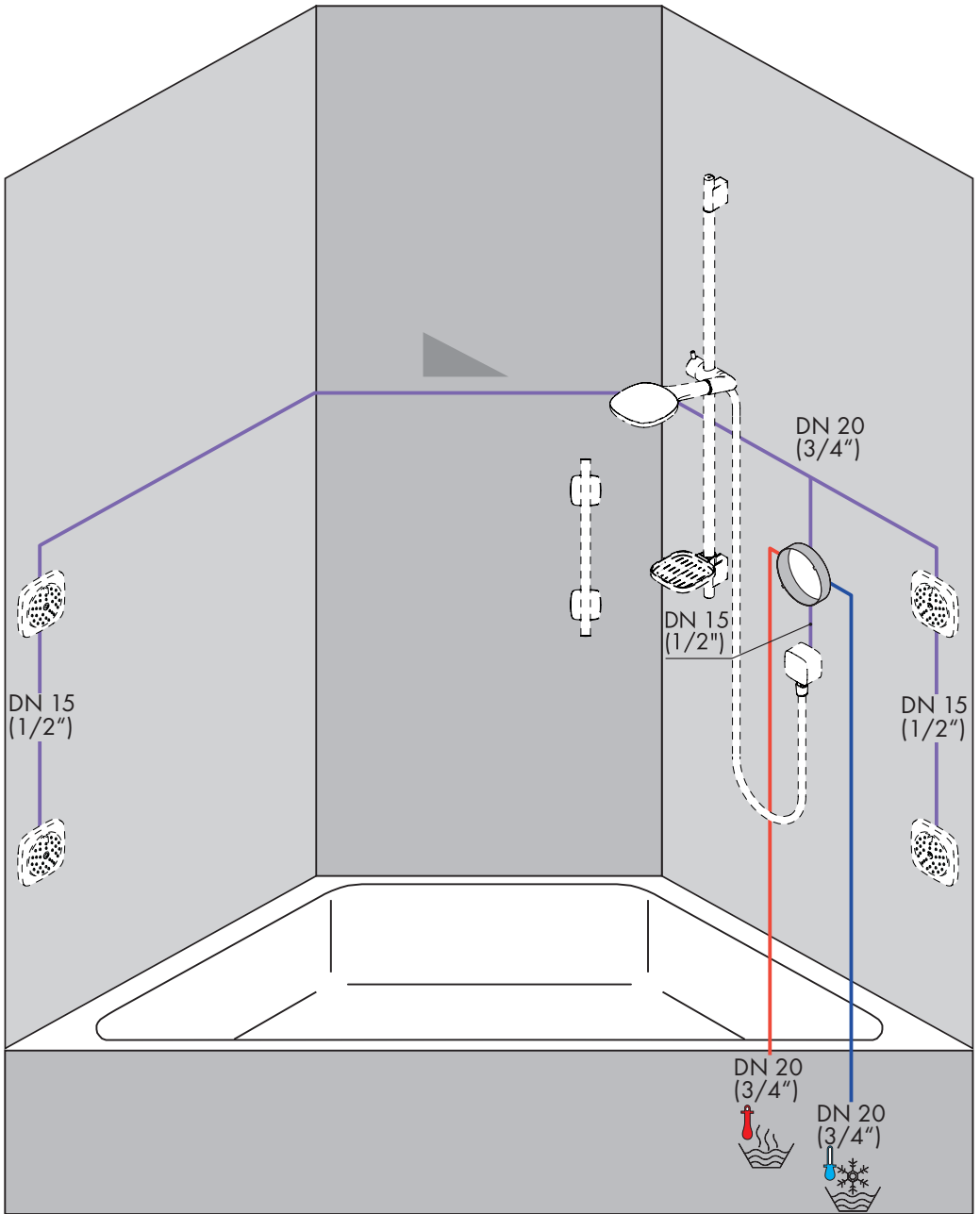

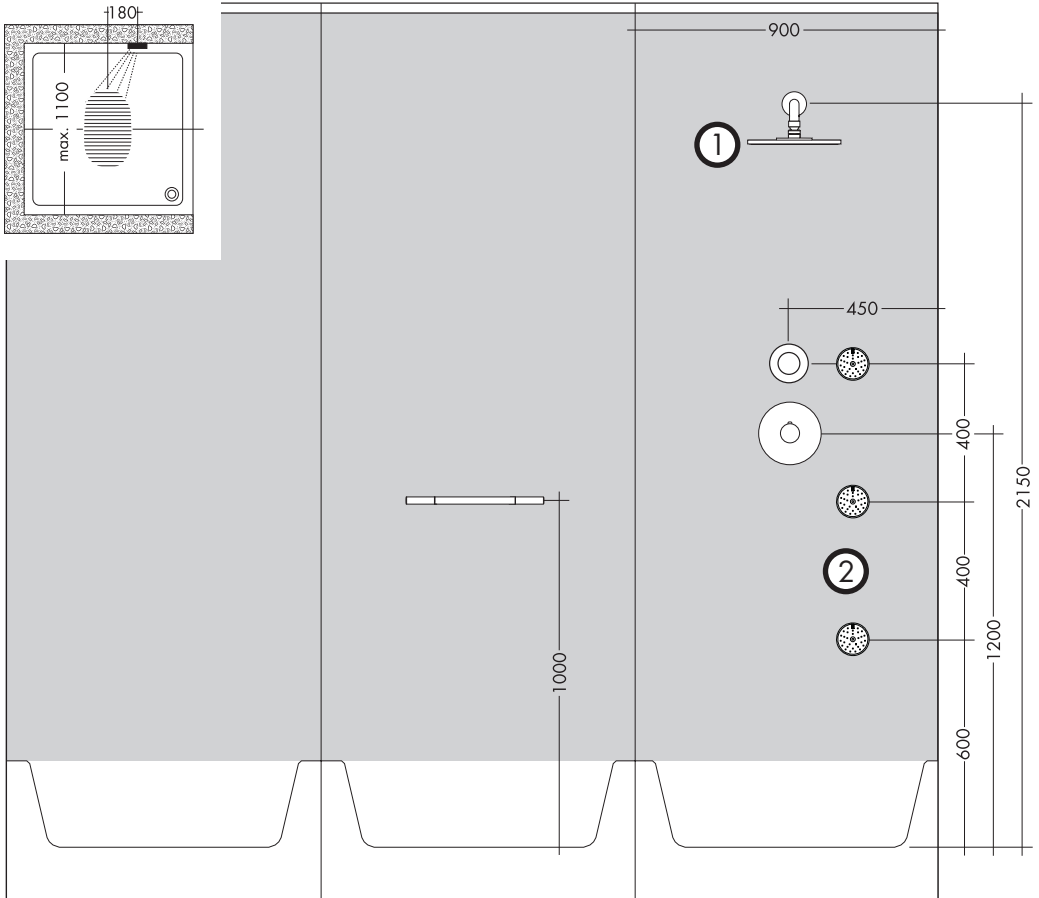
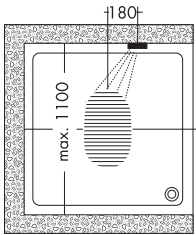
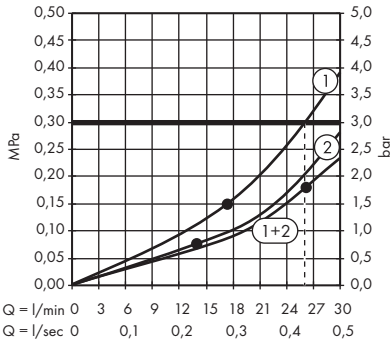
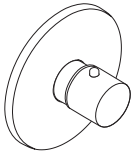

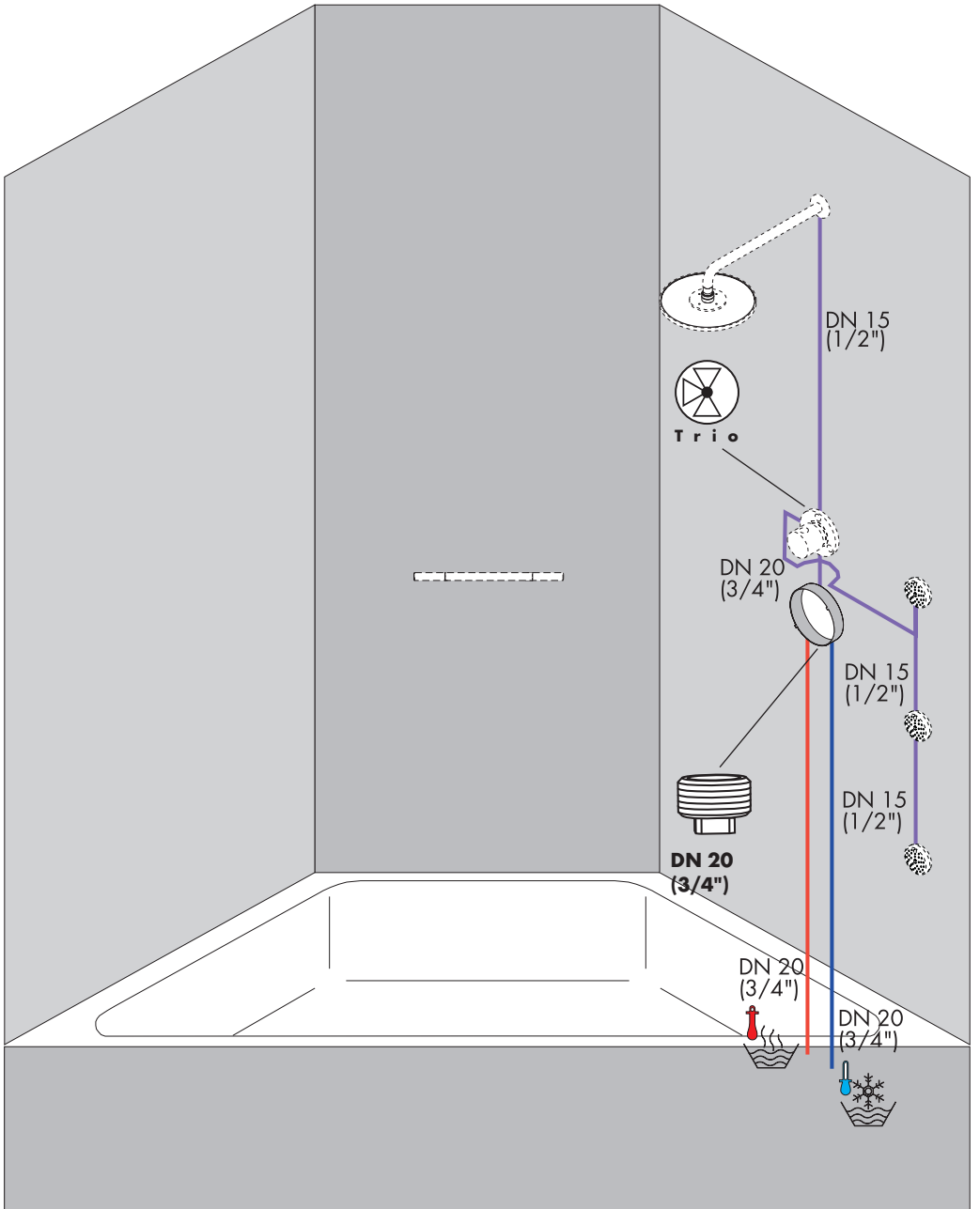

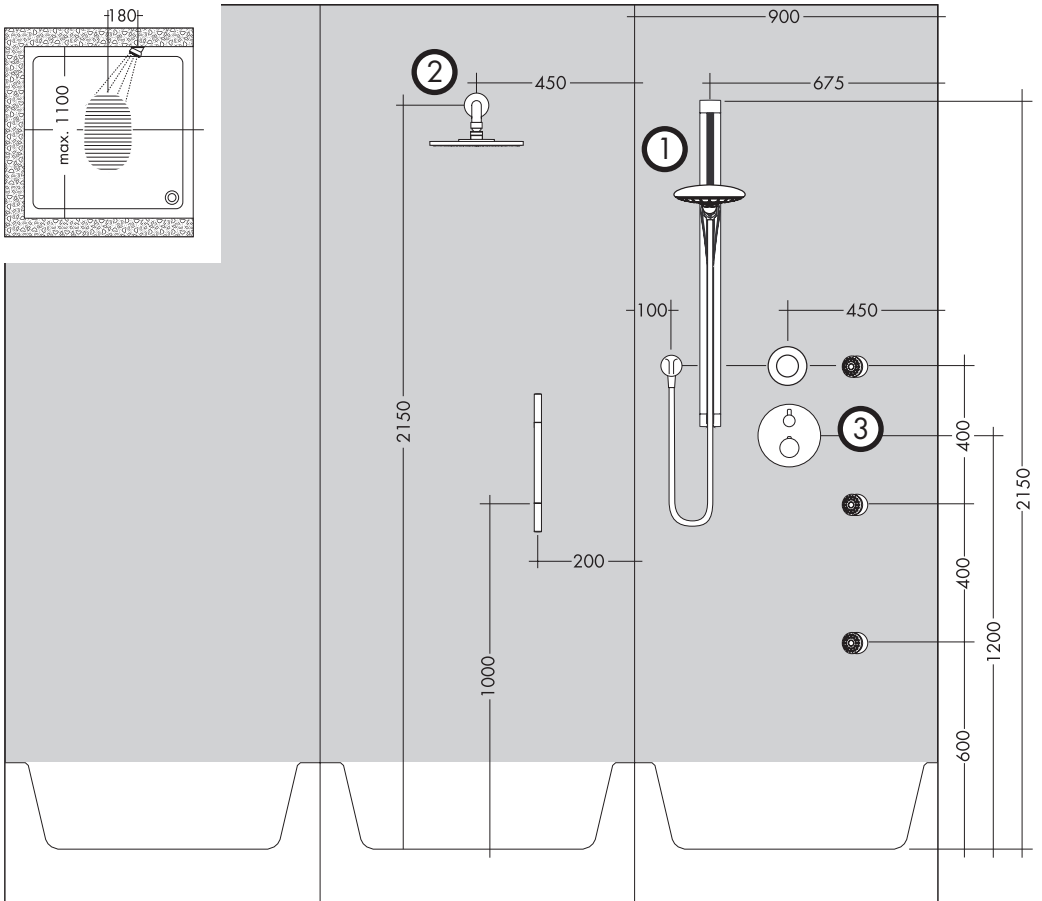
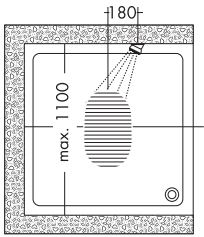
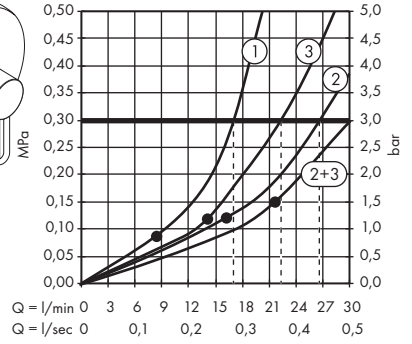
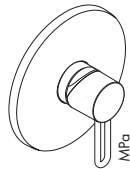
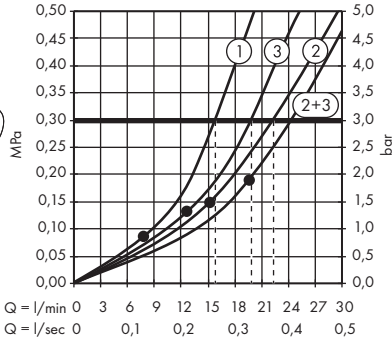
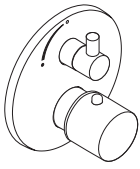

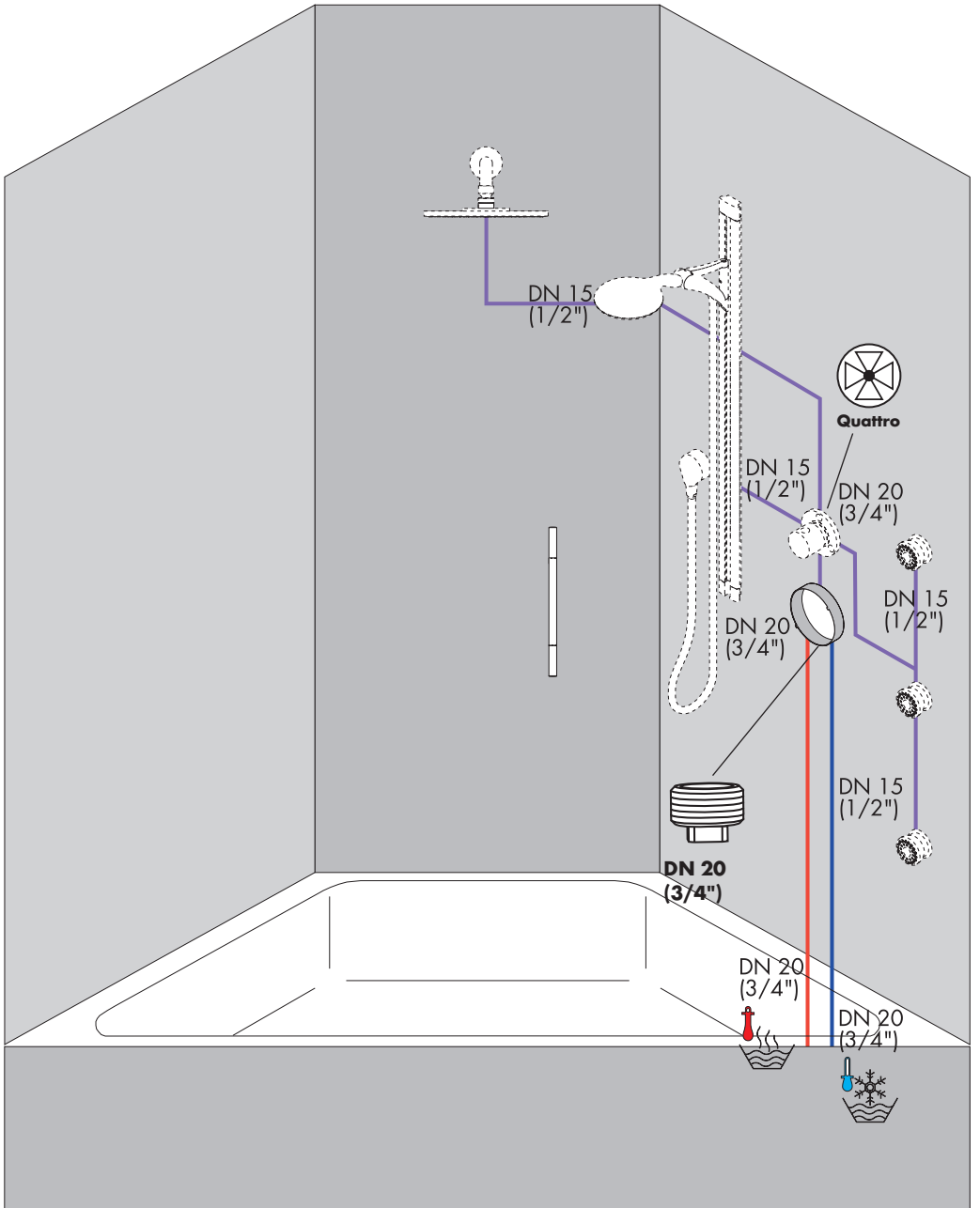

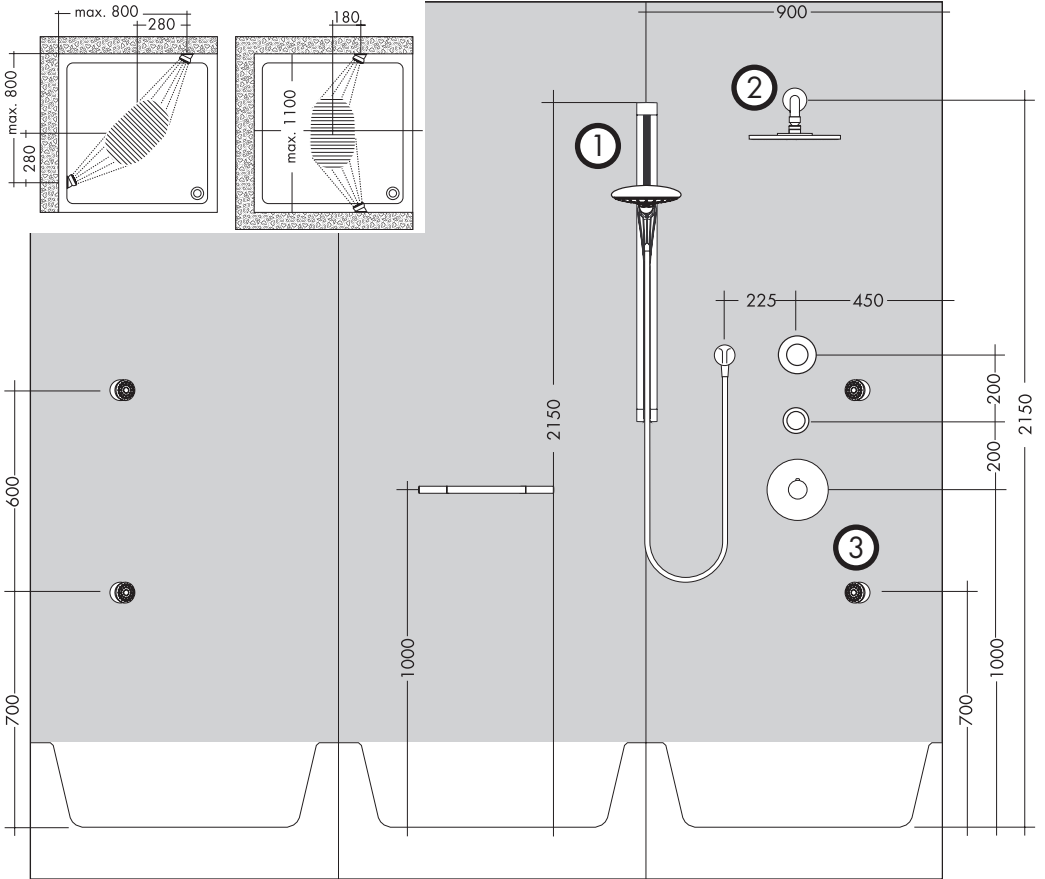
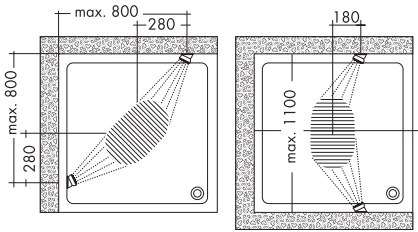
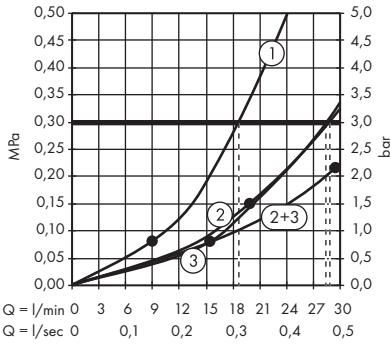
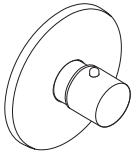

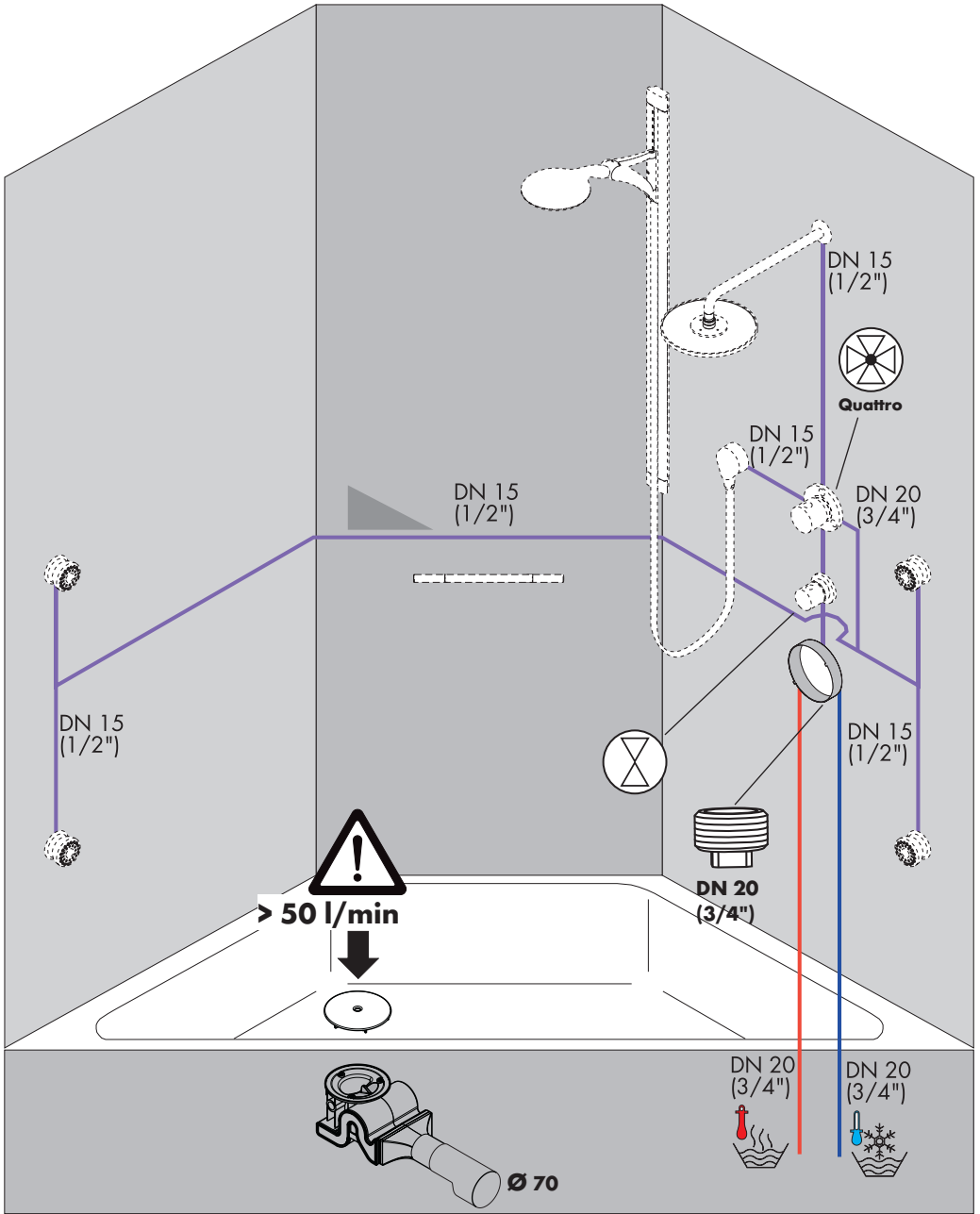

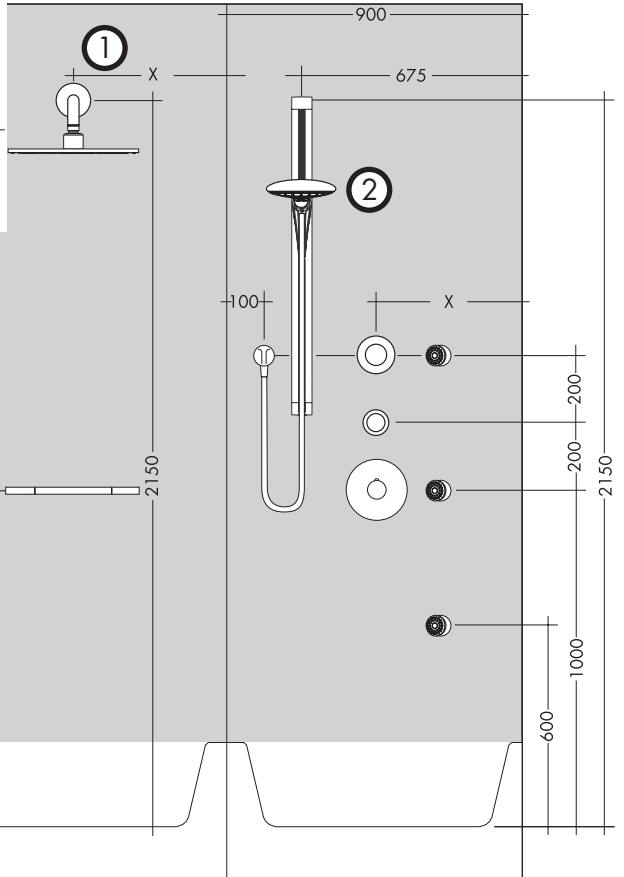
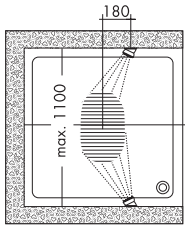
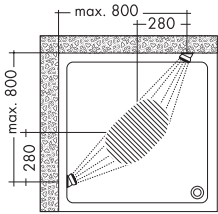
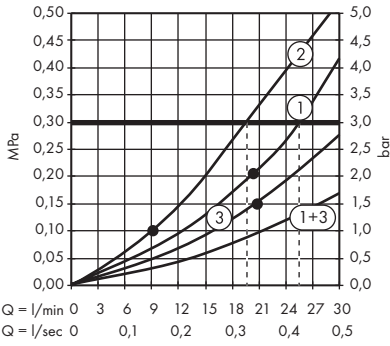
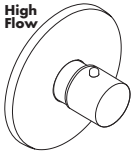

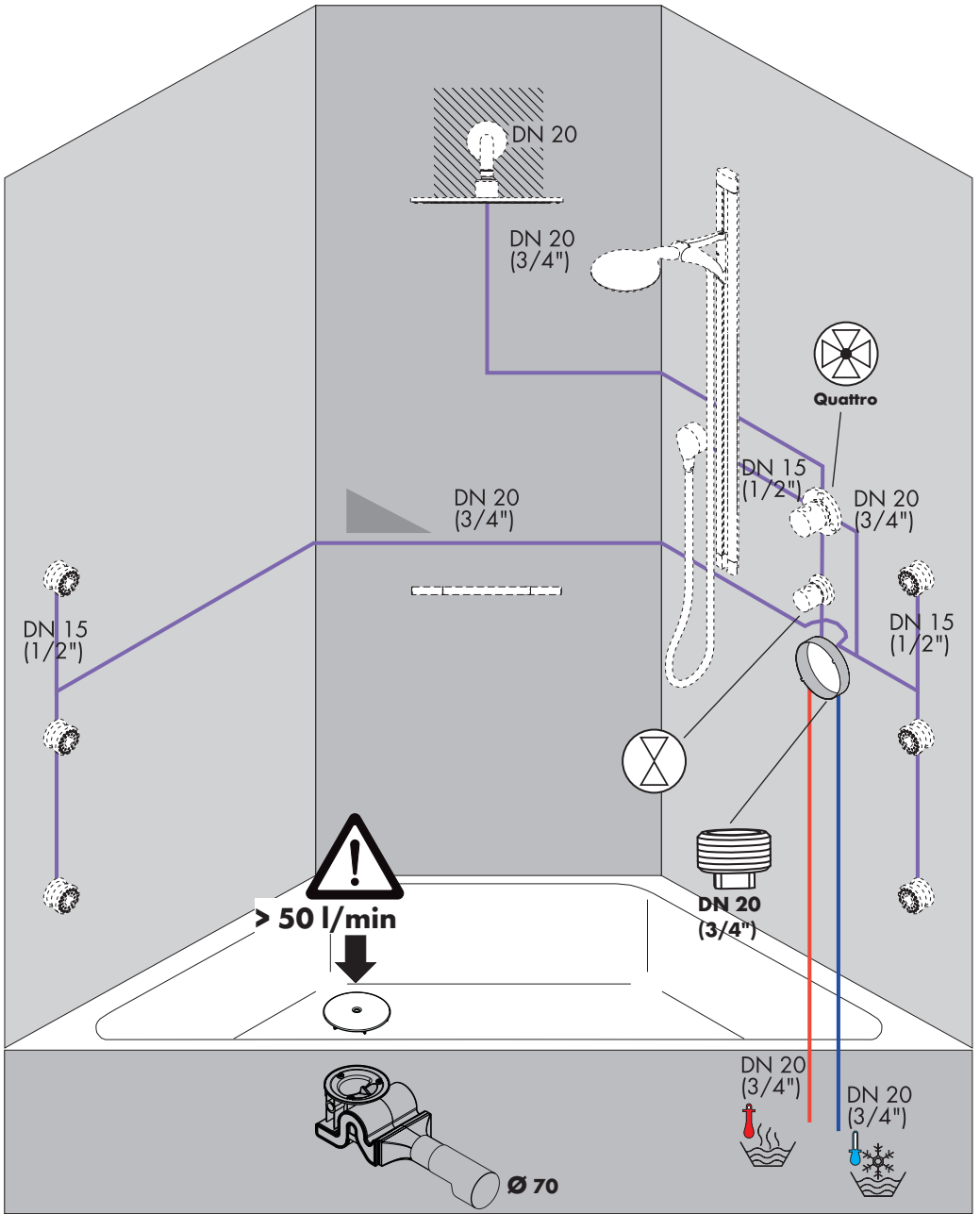

High Flow

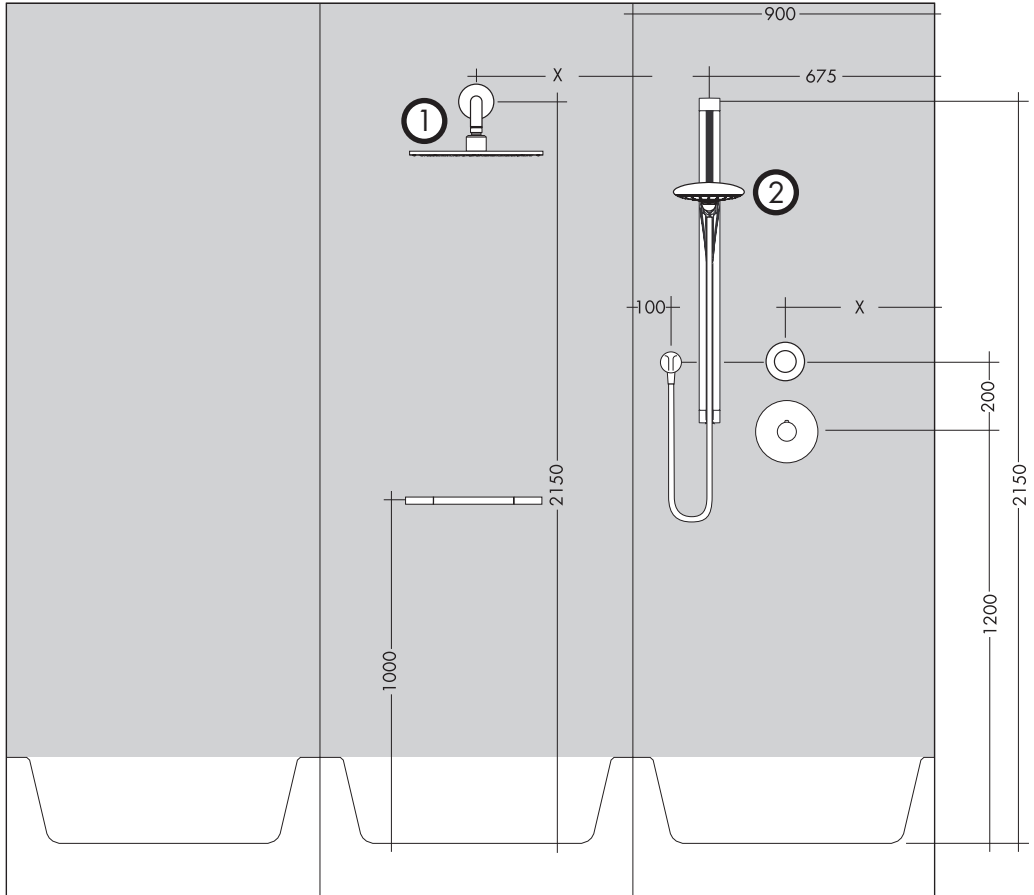
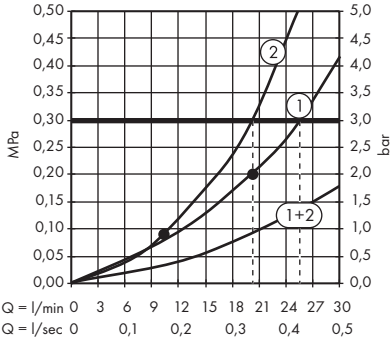
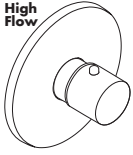

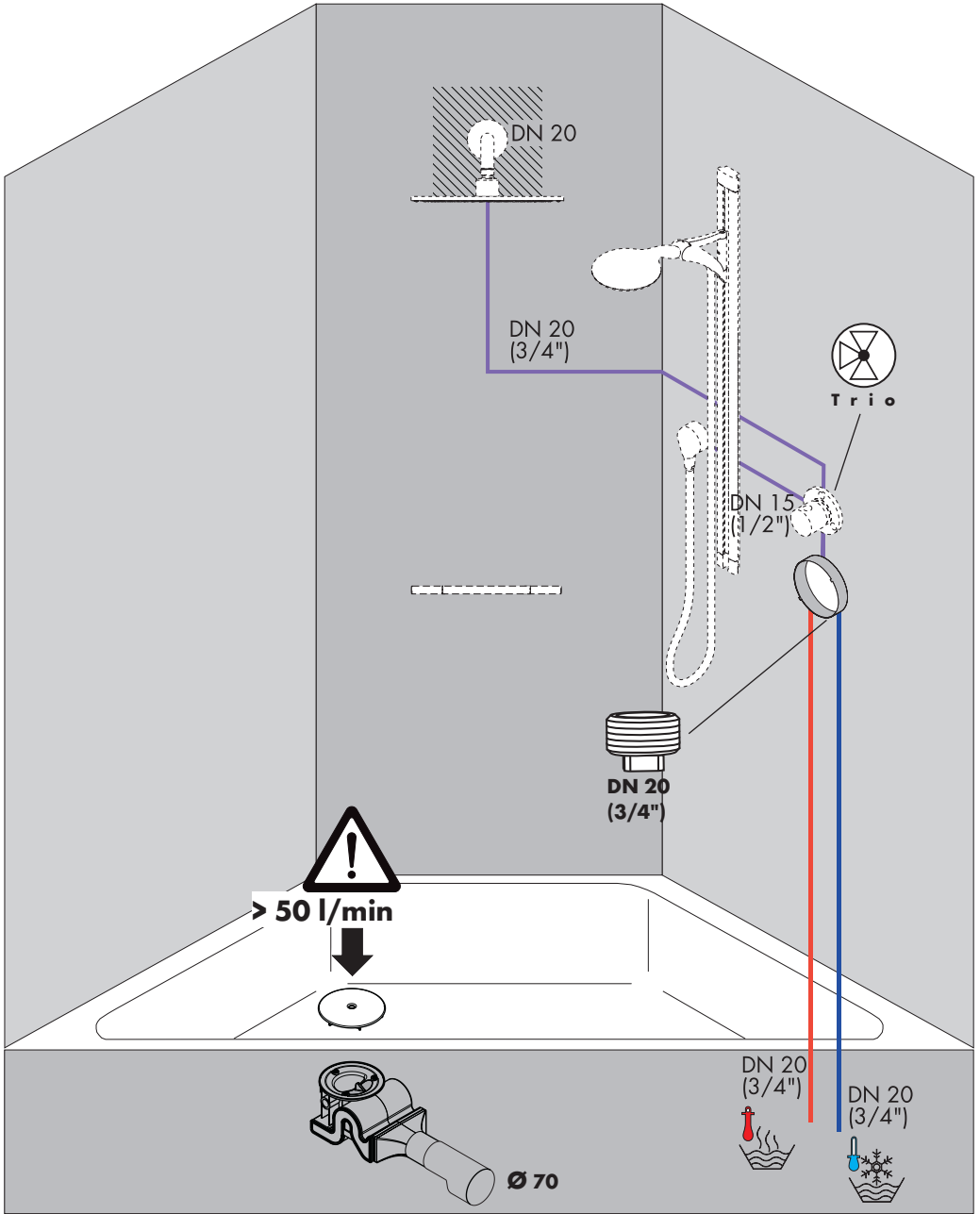

High Flow

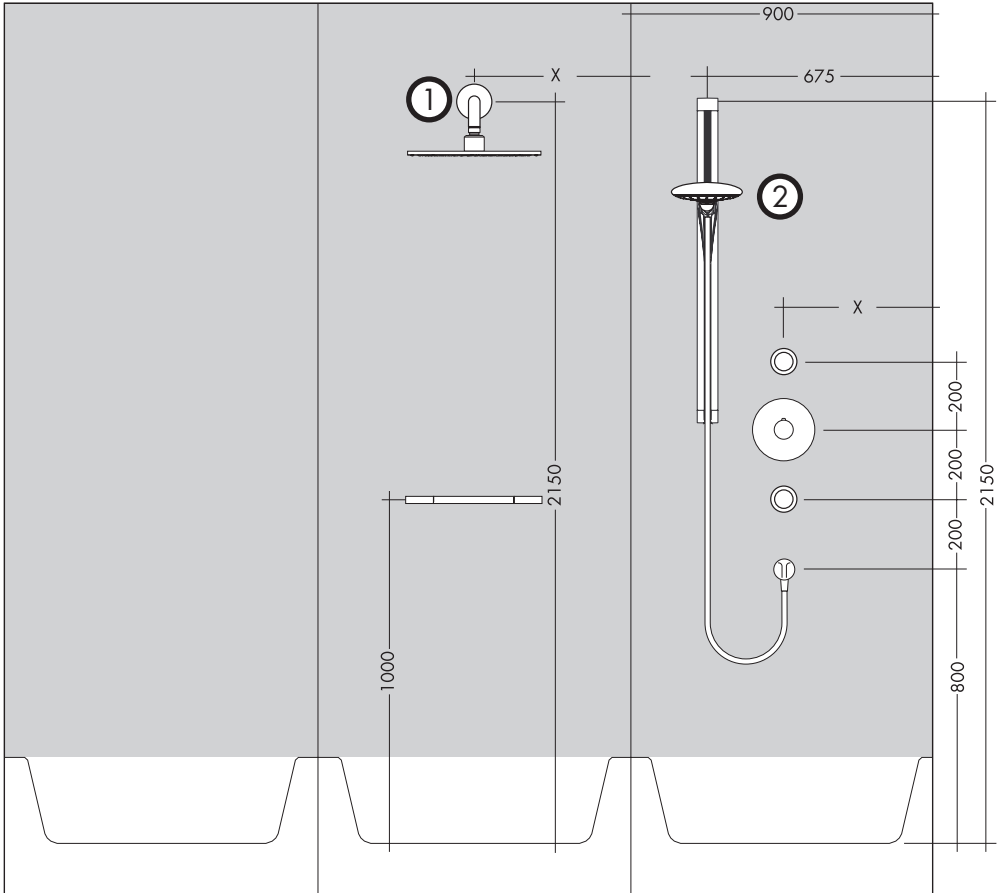
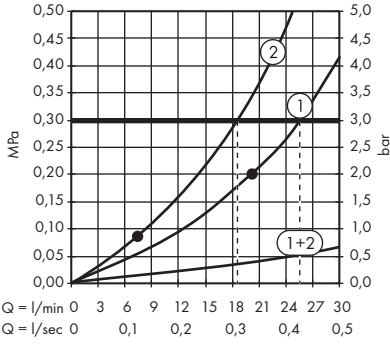
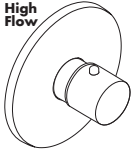

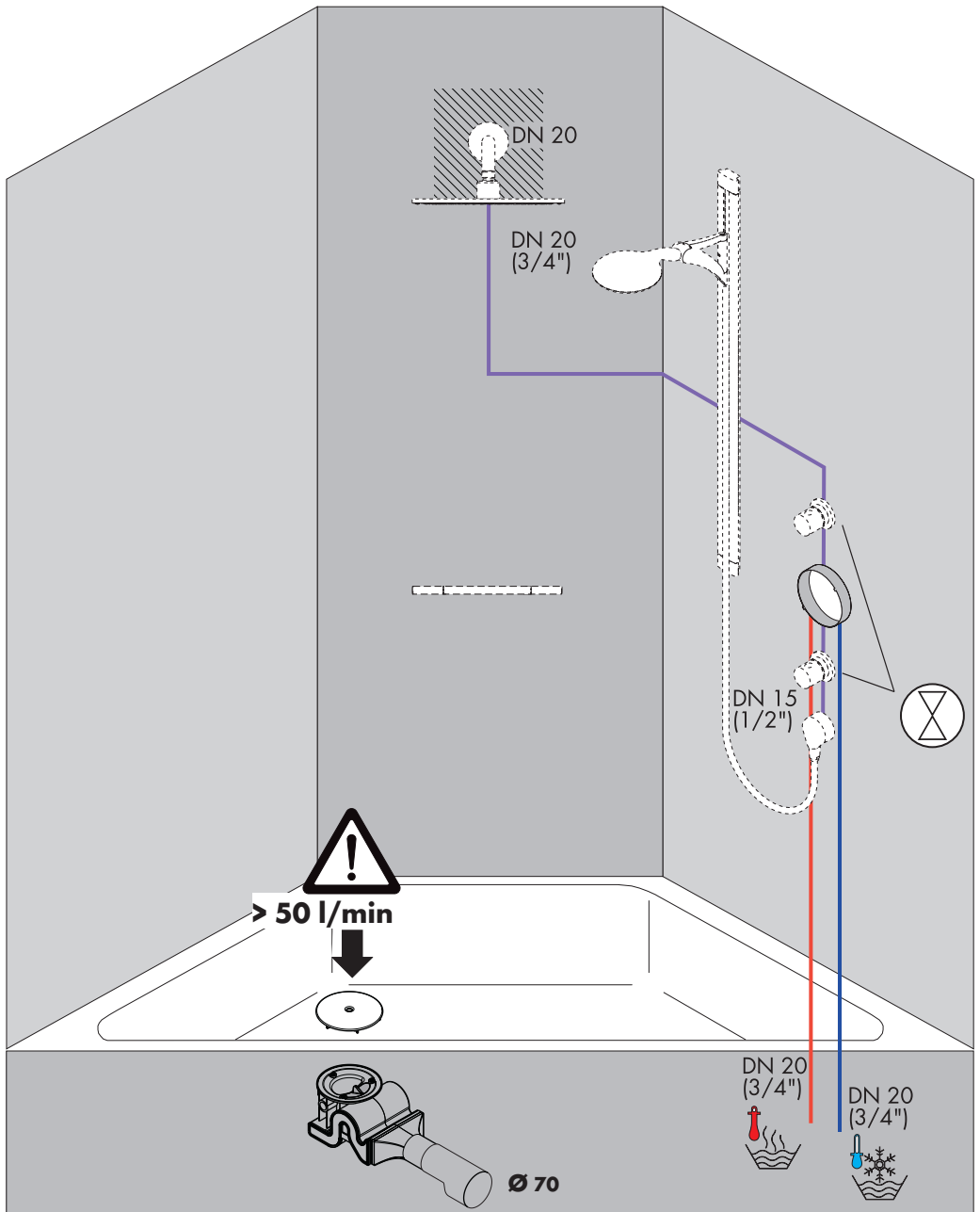

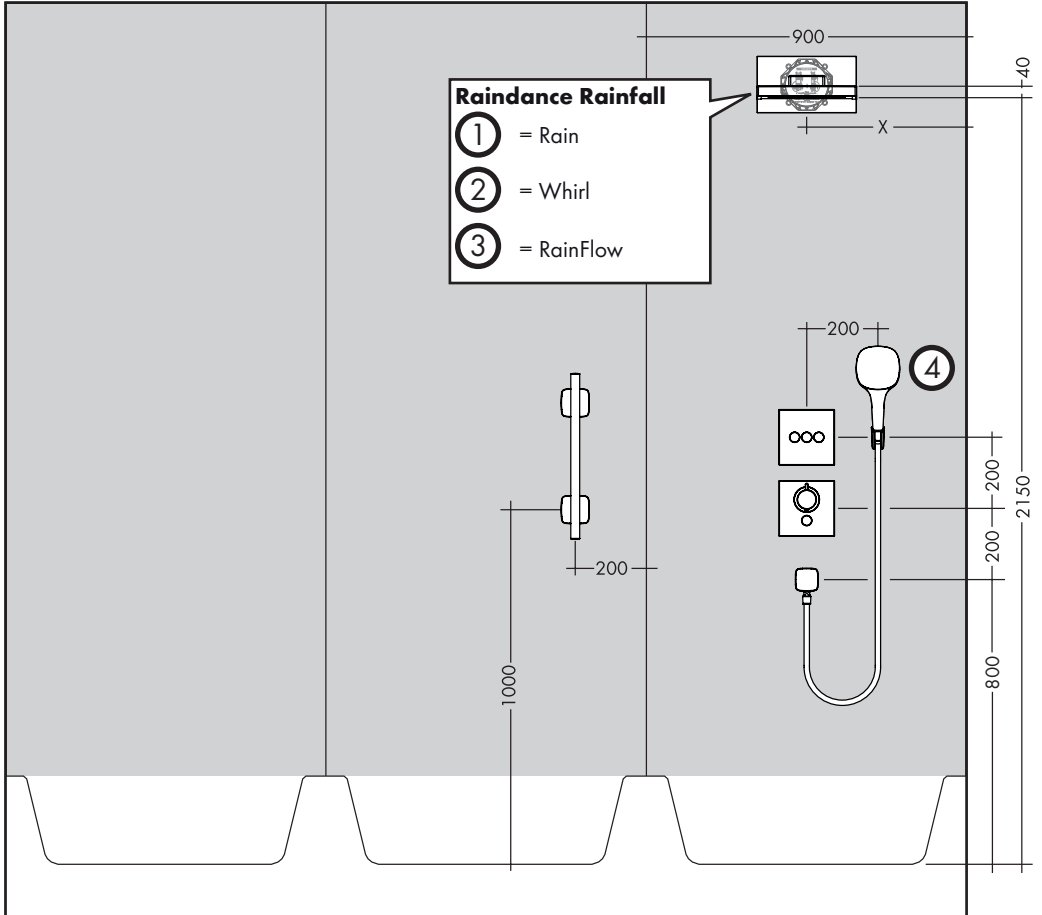
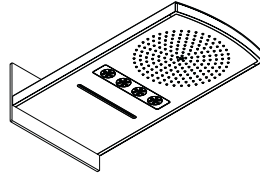
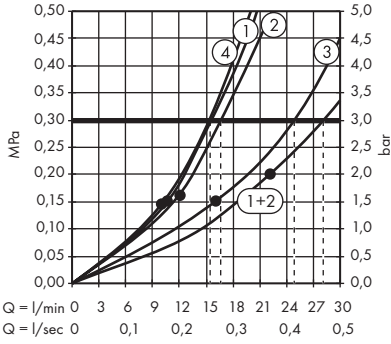
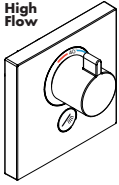
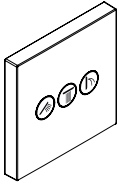

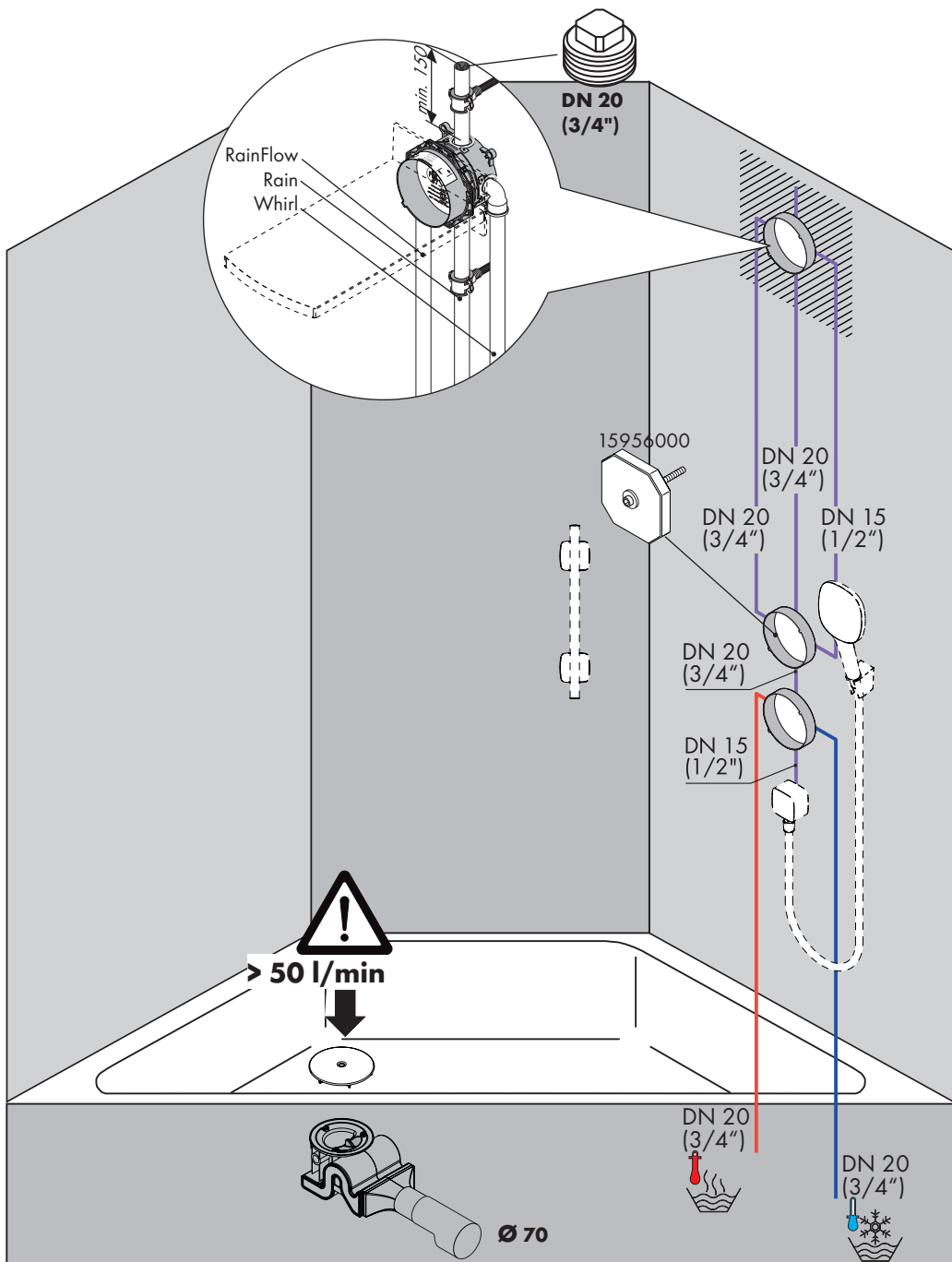

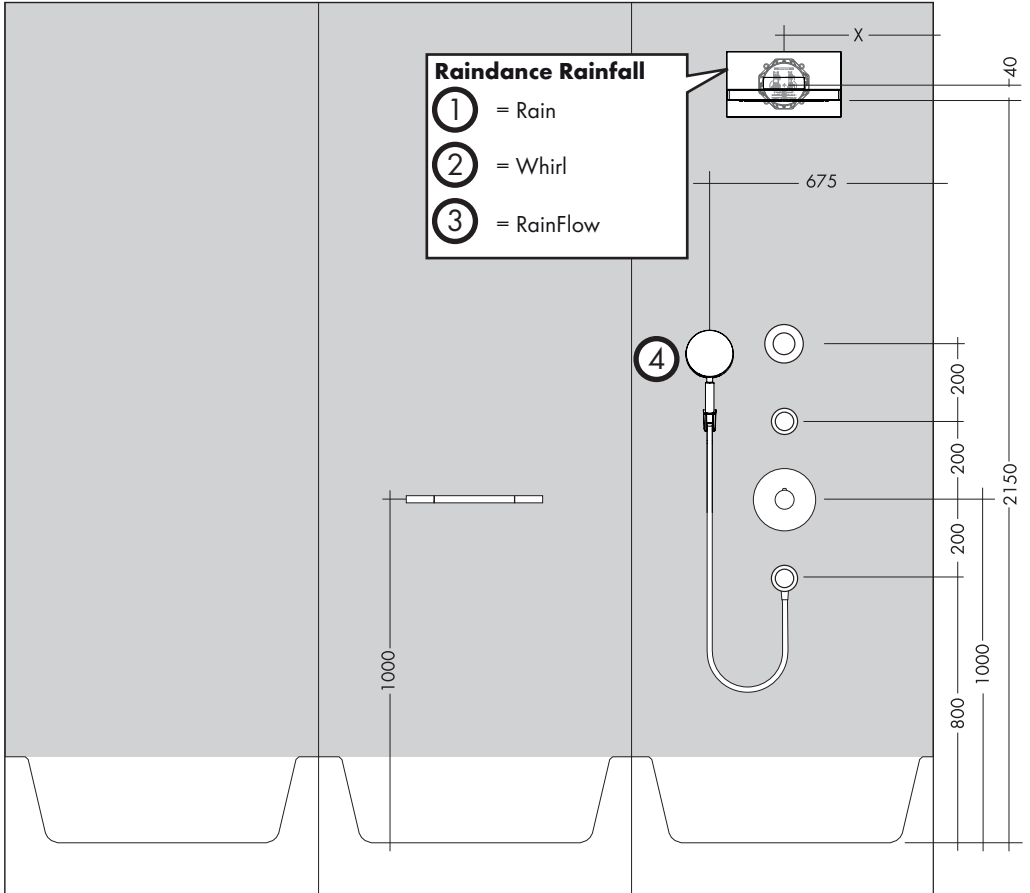
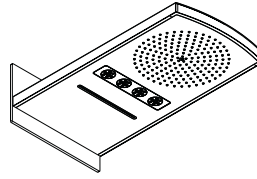
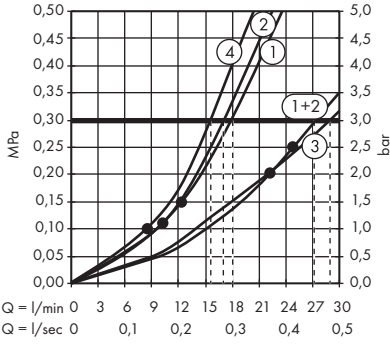
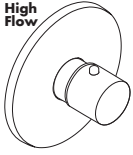

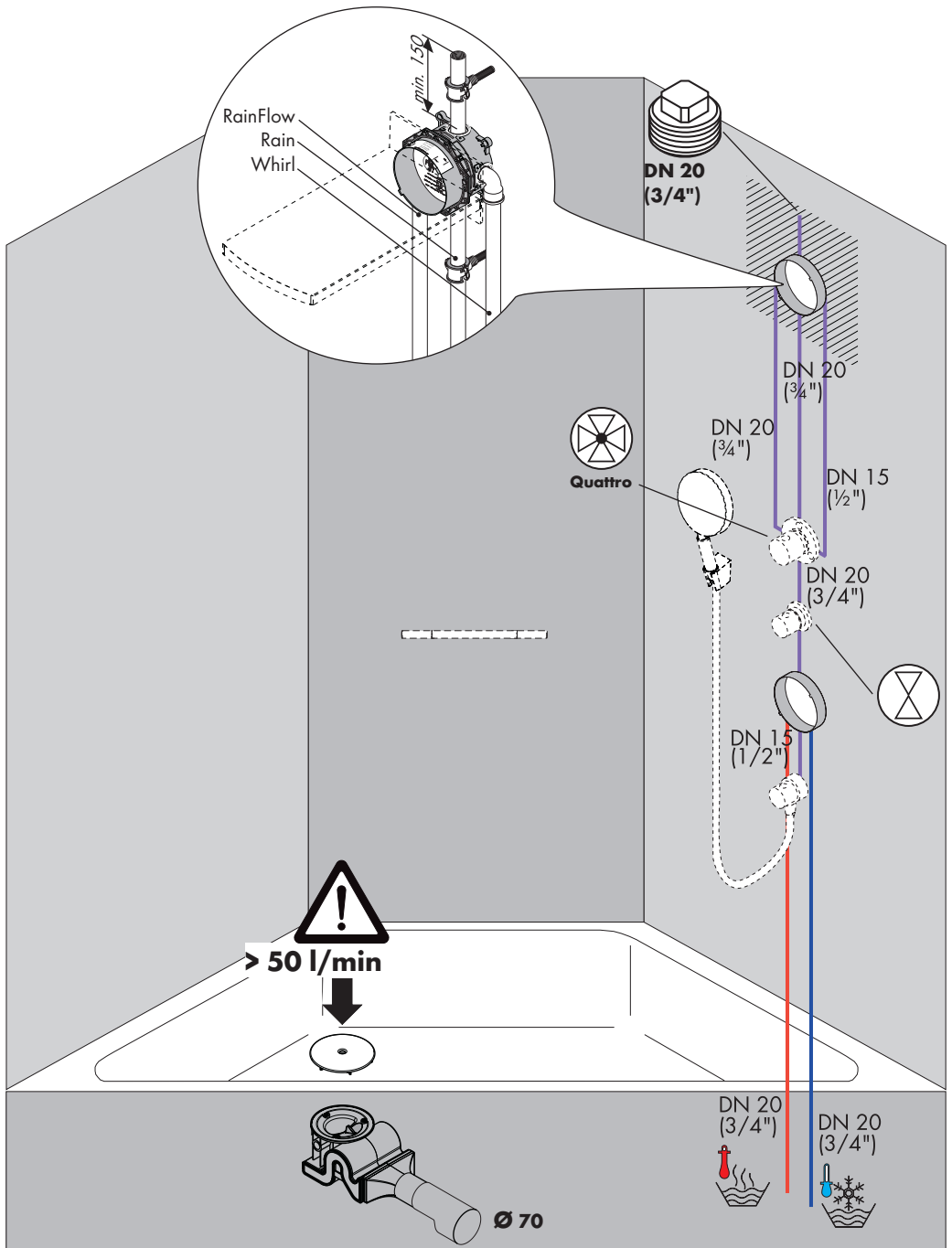

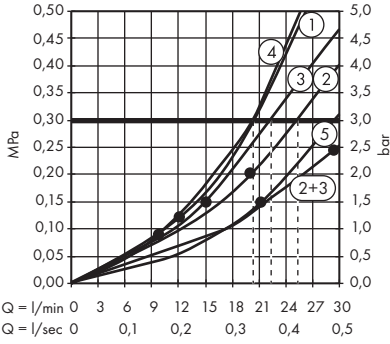
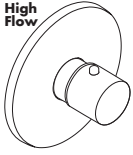

Raindance Rainmaker

- ① = Rain AIR
- ② = Rain AIR XXL
- ③ = Whirl AIR

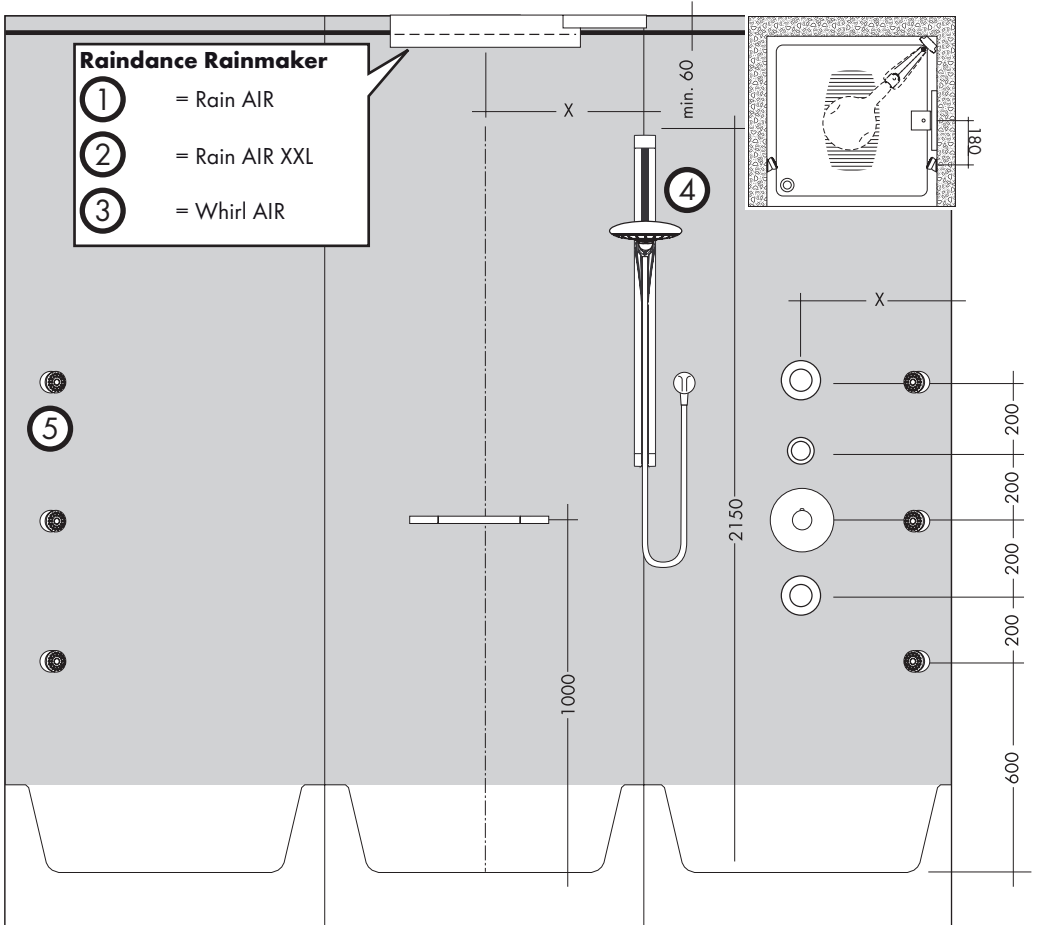

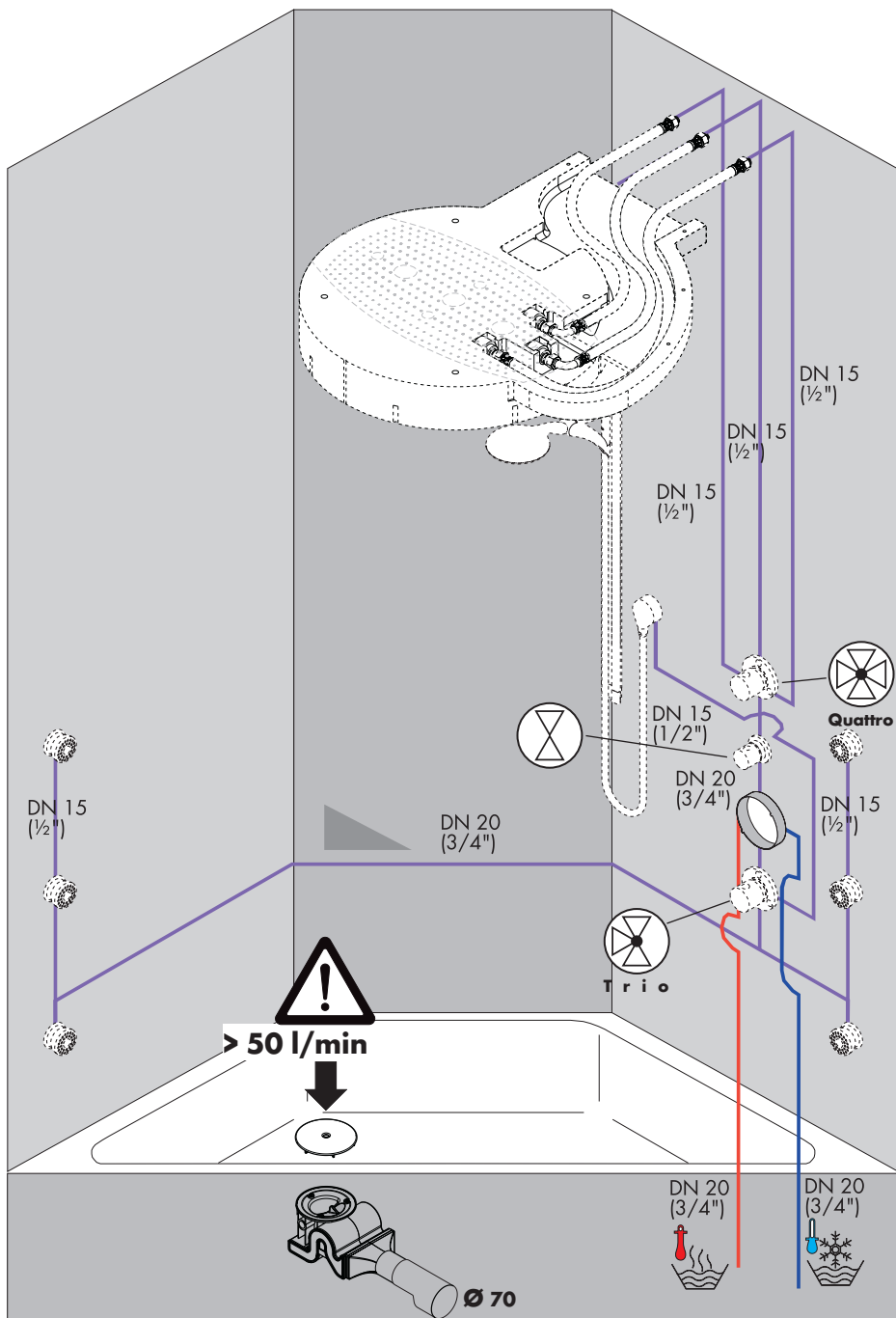

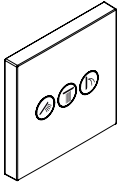

High Flow

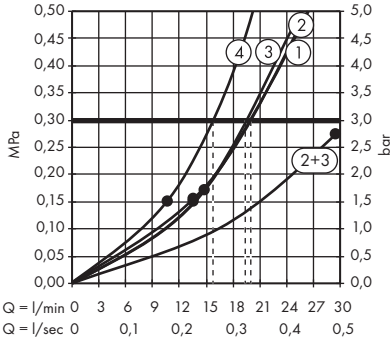
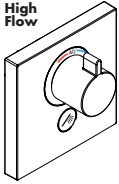

Raindance Rainmaker

- ① = Rain AIR
- ② = Rain AIR XXL
- ③ = Whirl AIR

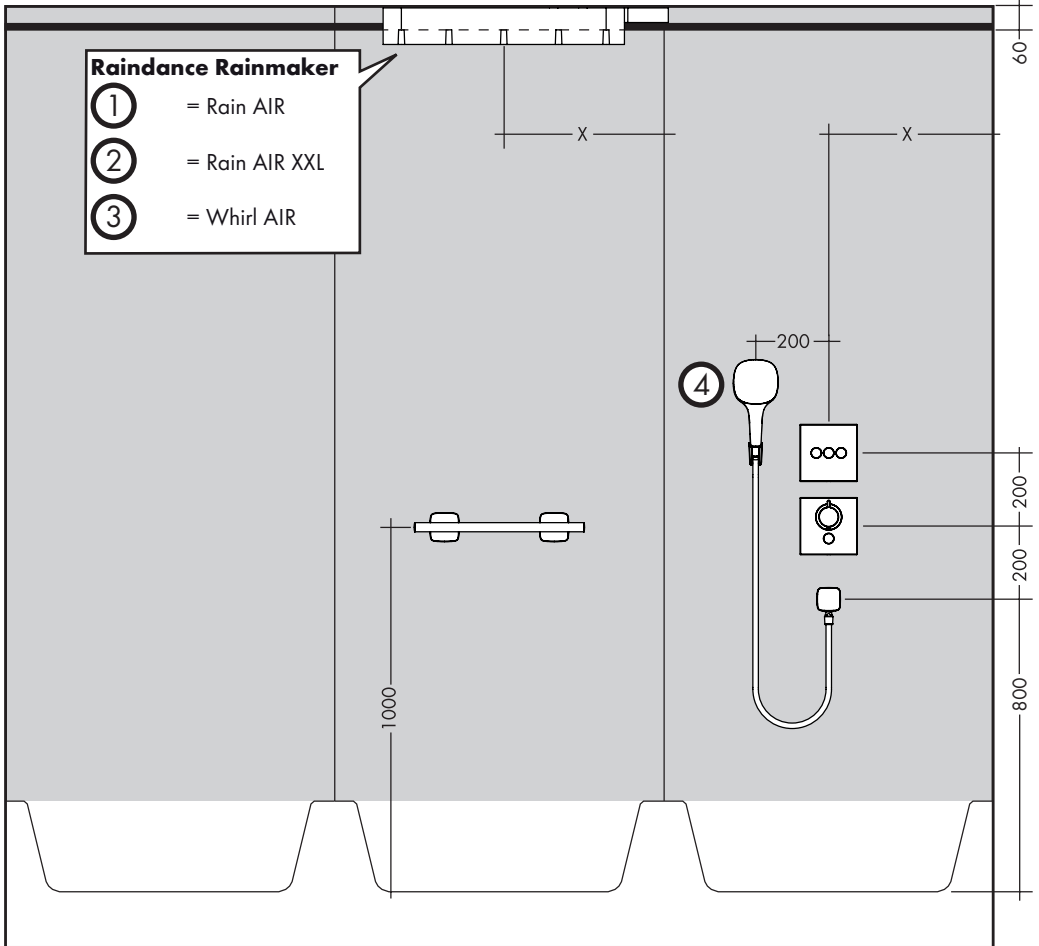

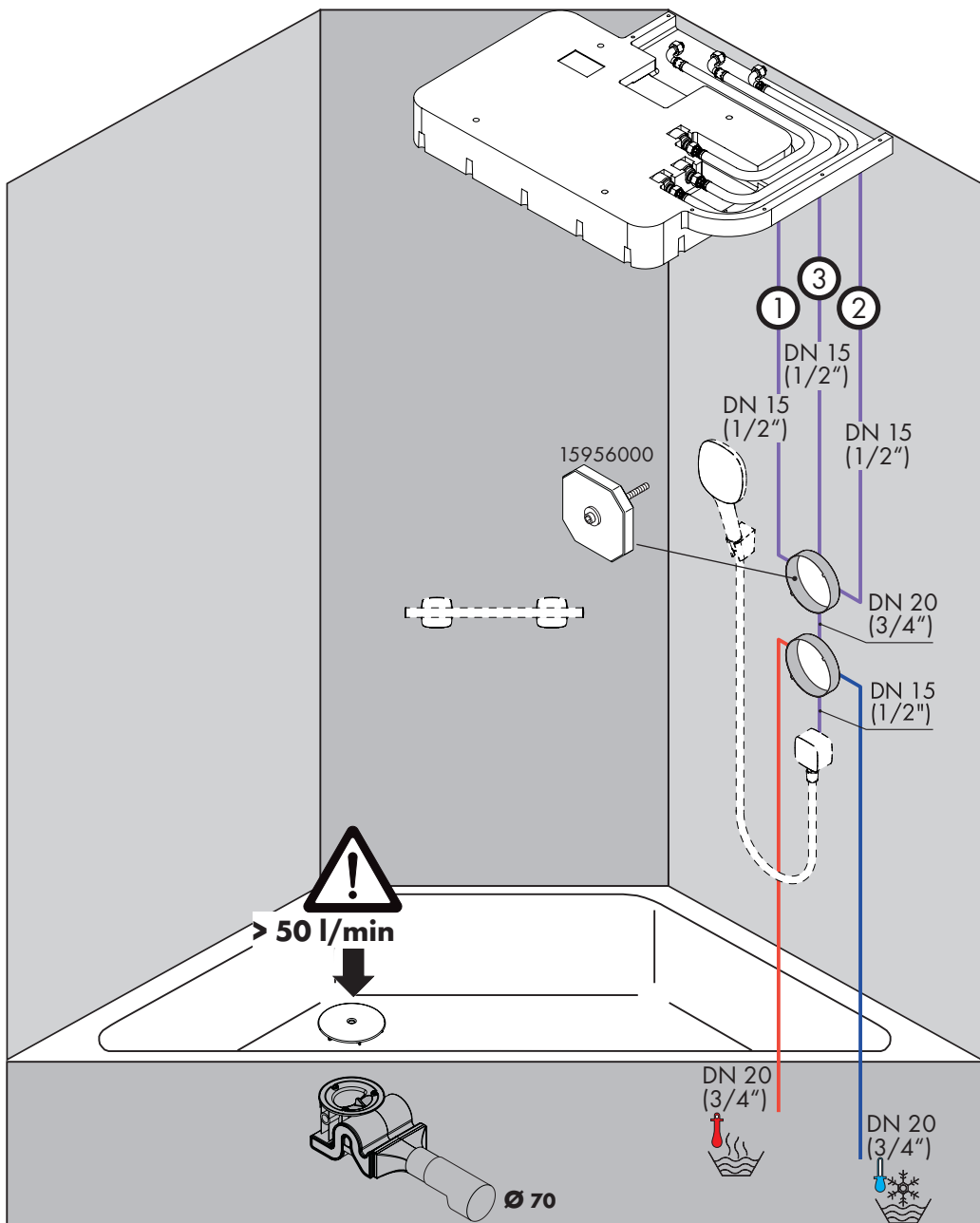

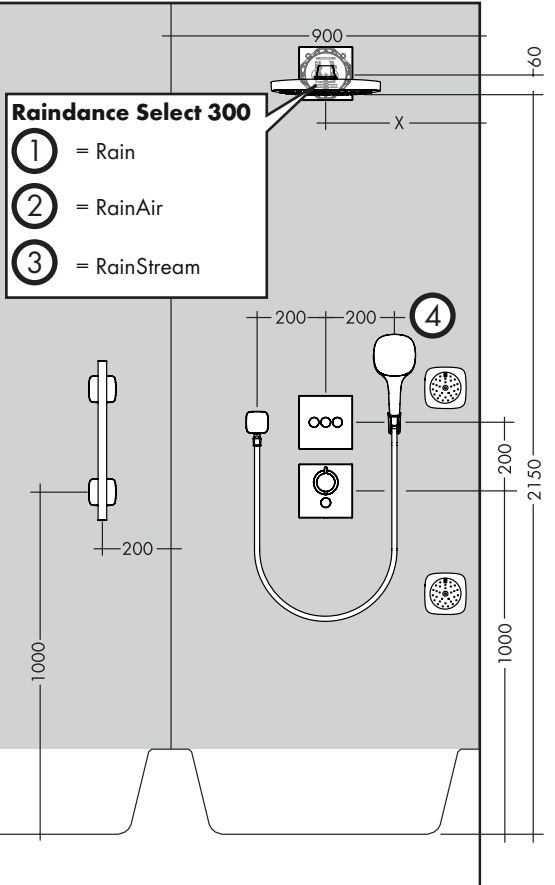
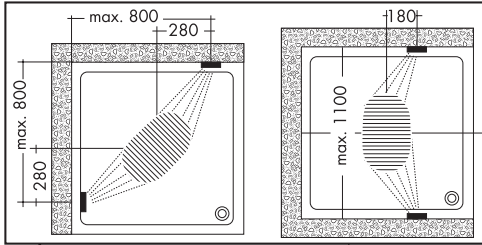
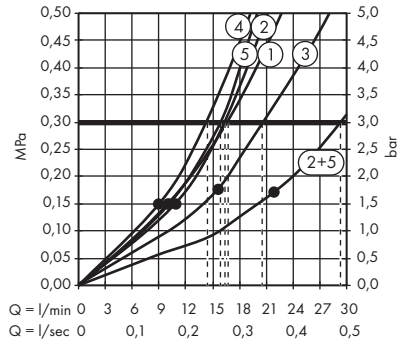
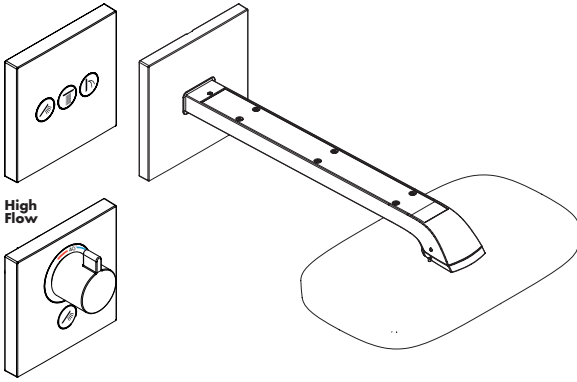

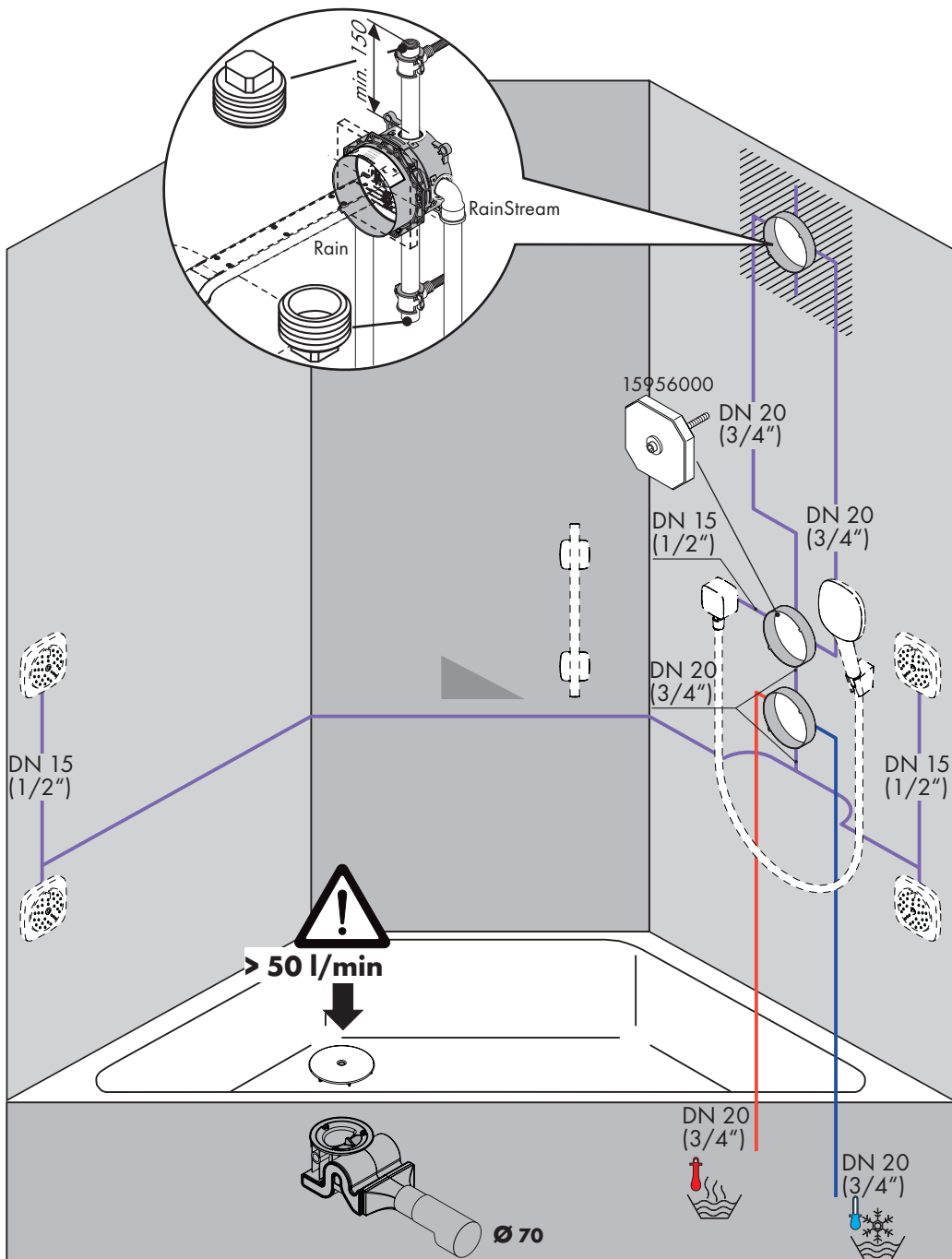

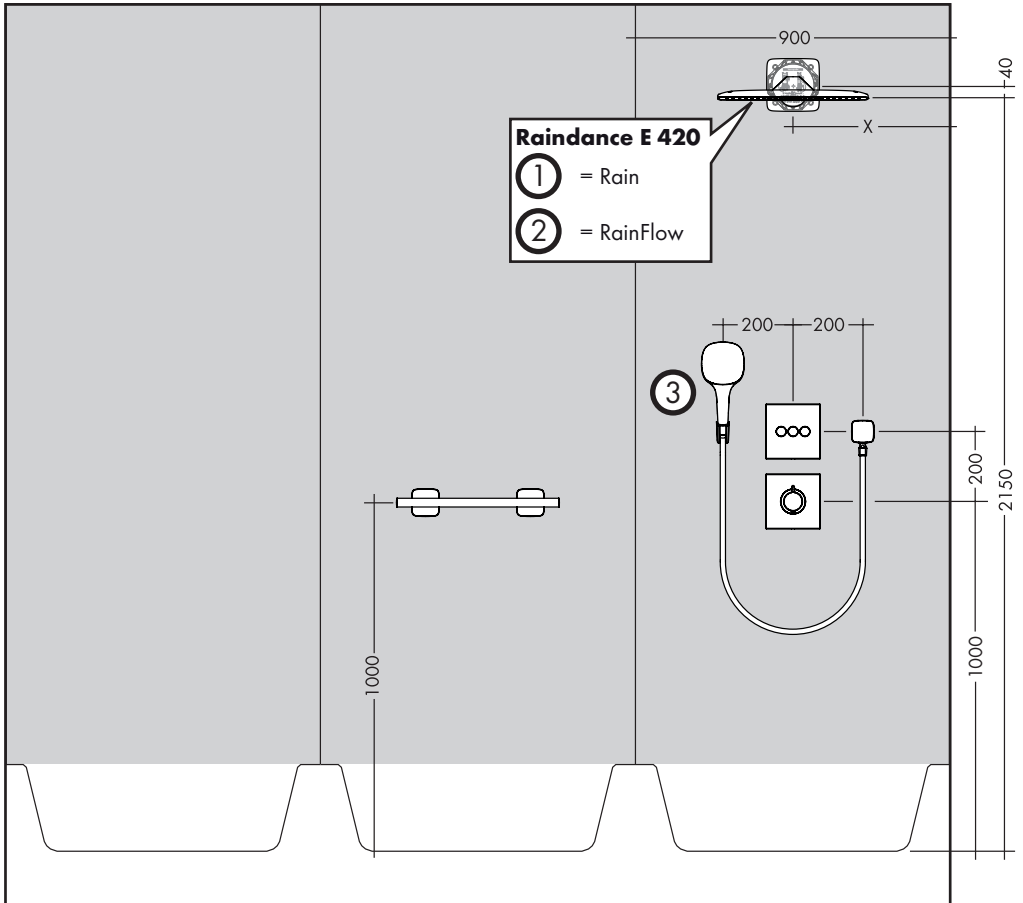
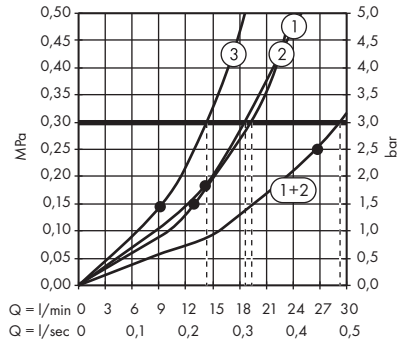
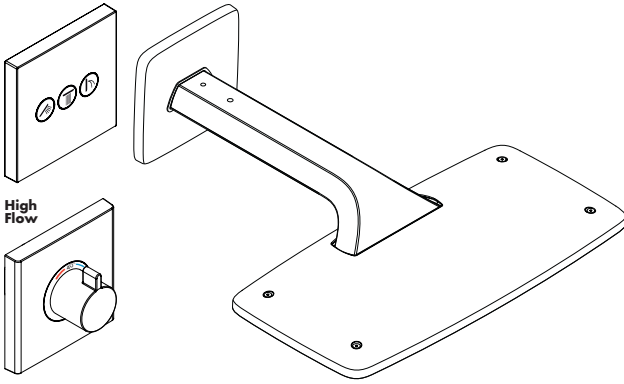

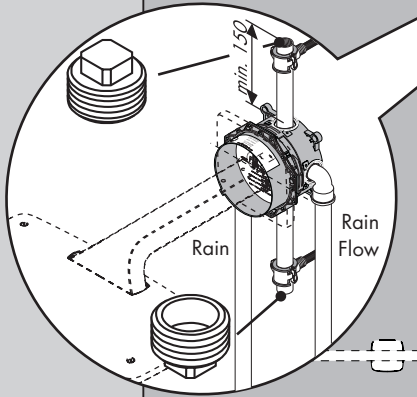
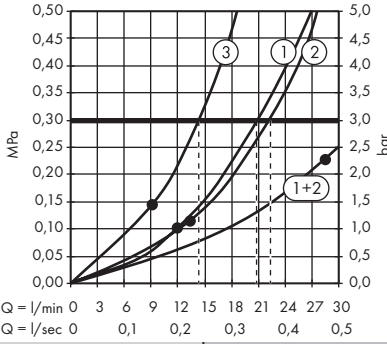
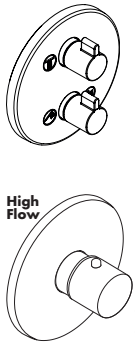

DN 20
(3/4")



DN 20
(3/4") 15956000

DN 20
(3/4")

DN 15
(1/2")

DN 20
(3/4")

DN 20
(3/4")

DN 20
(3/4")

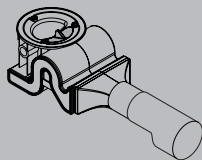

High Flow

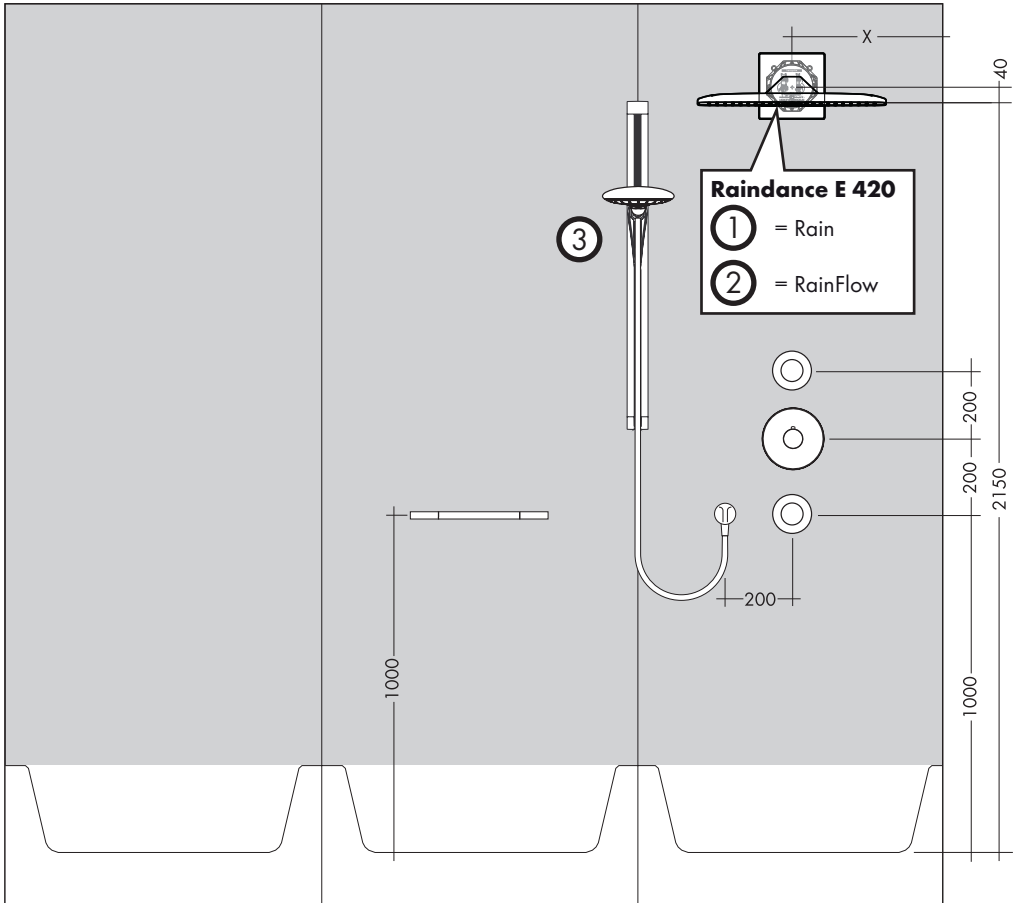
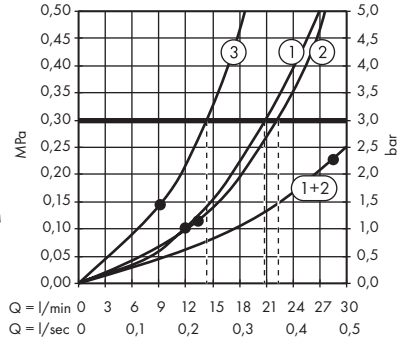
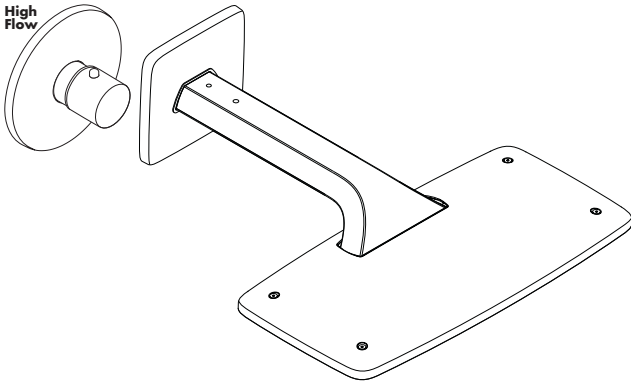

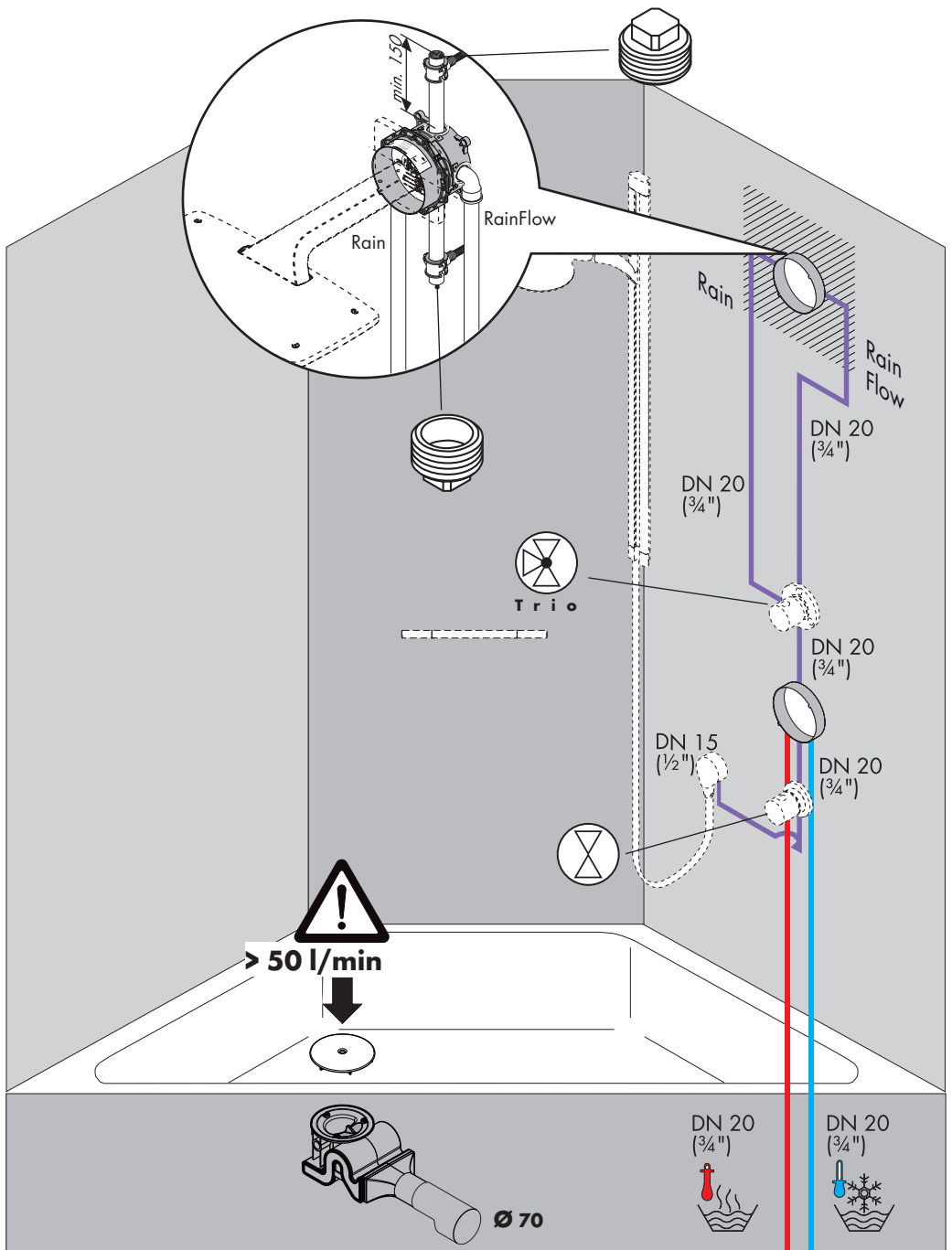

High Flow

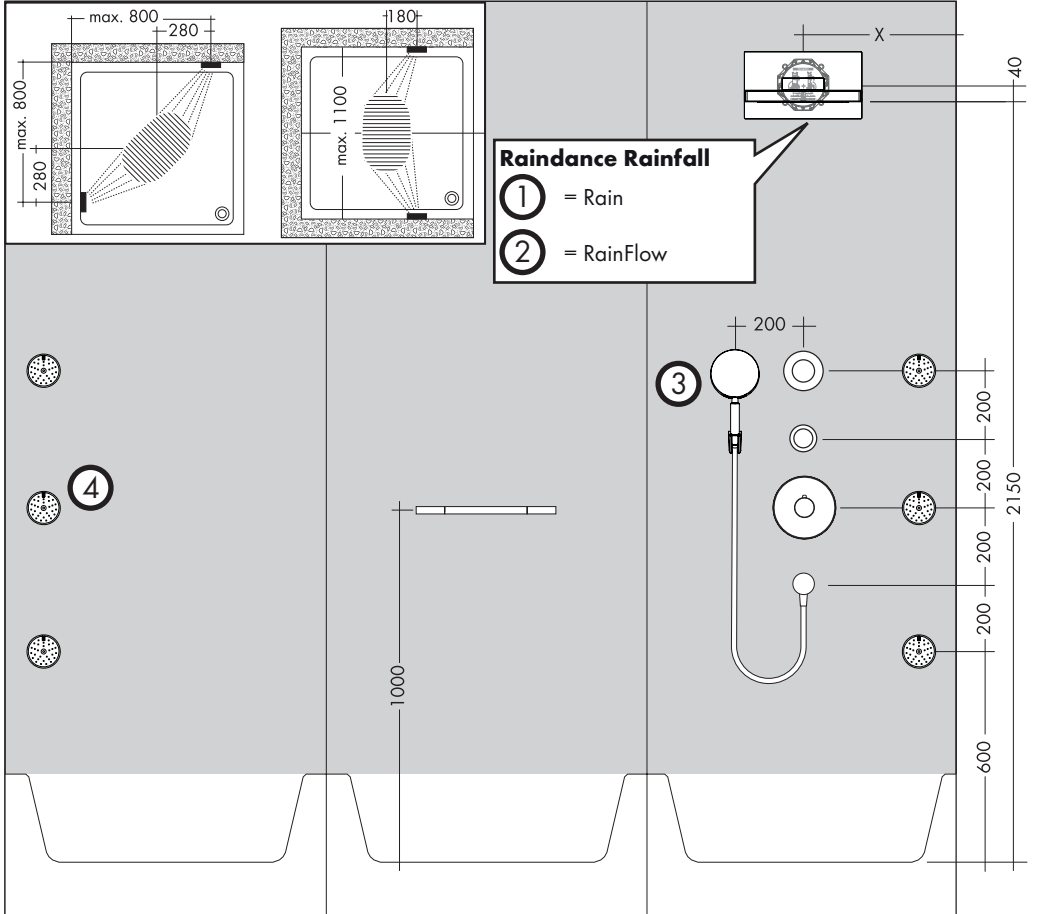
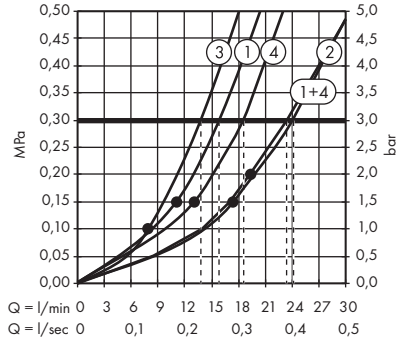
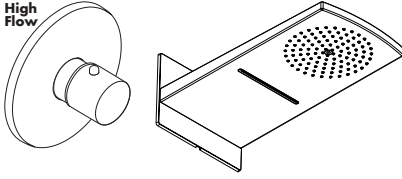

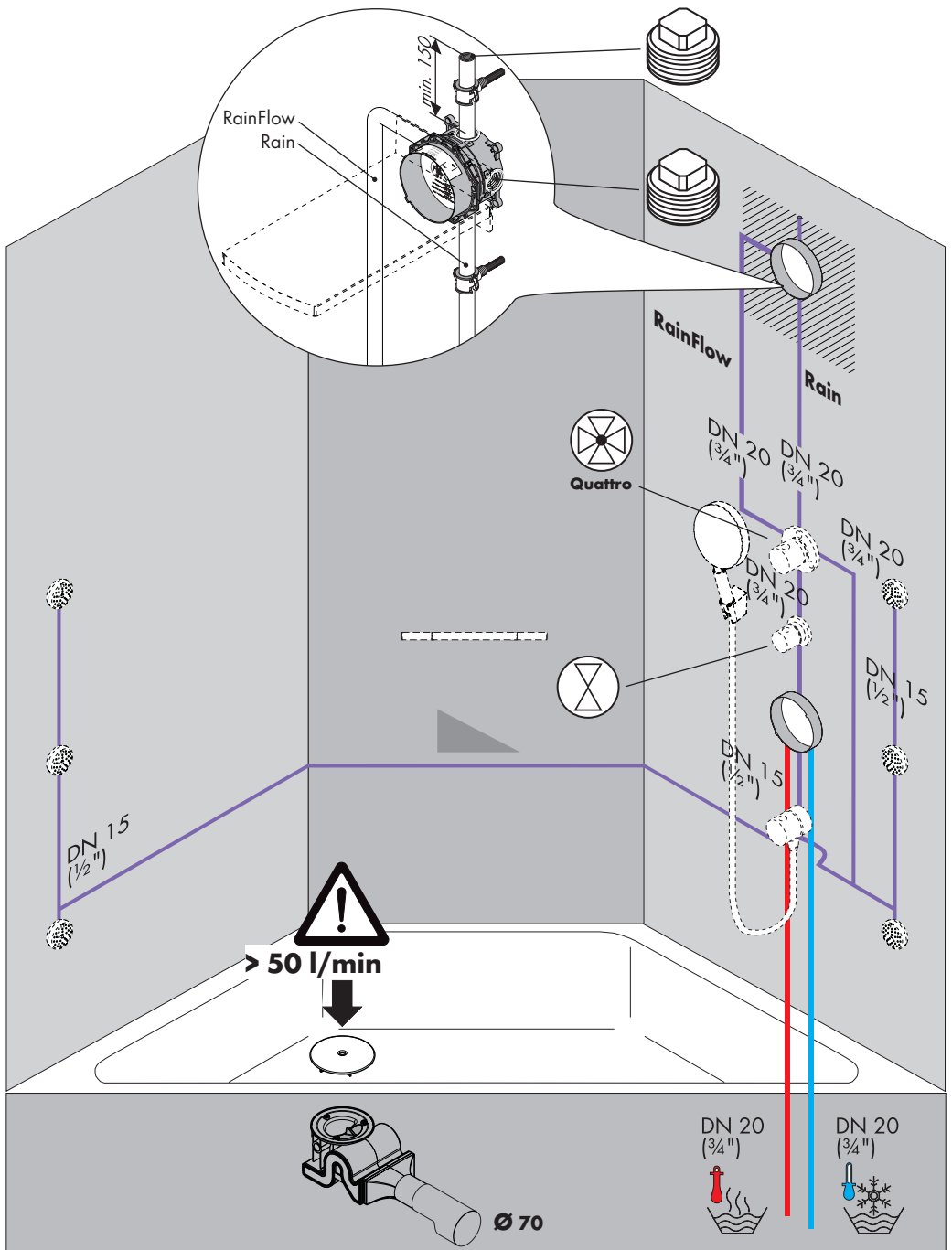

High Flow

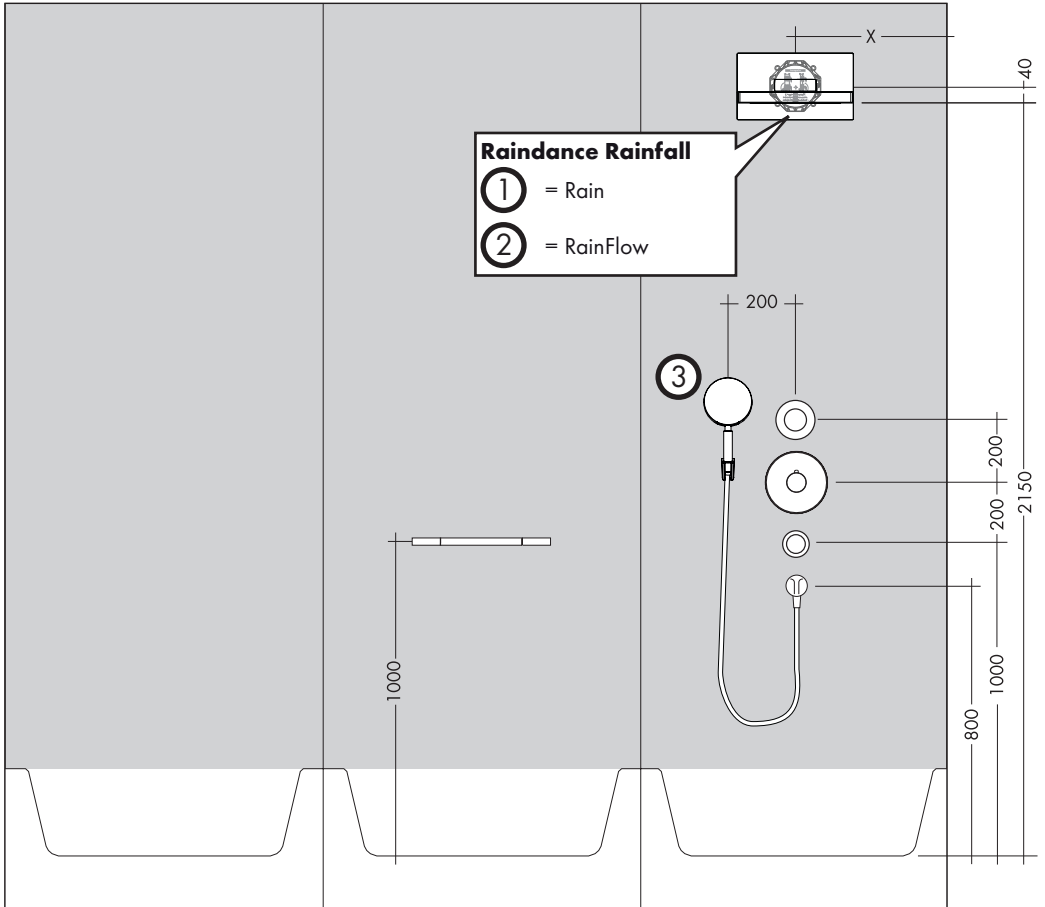
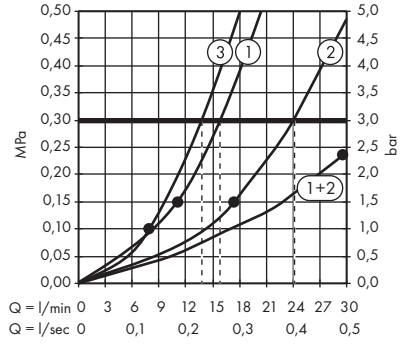
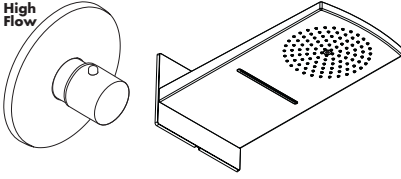

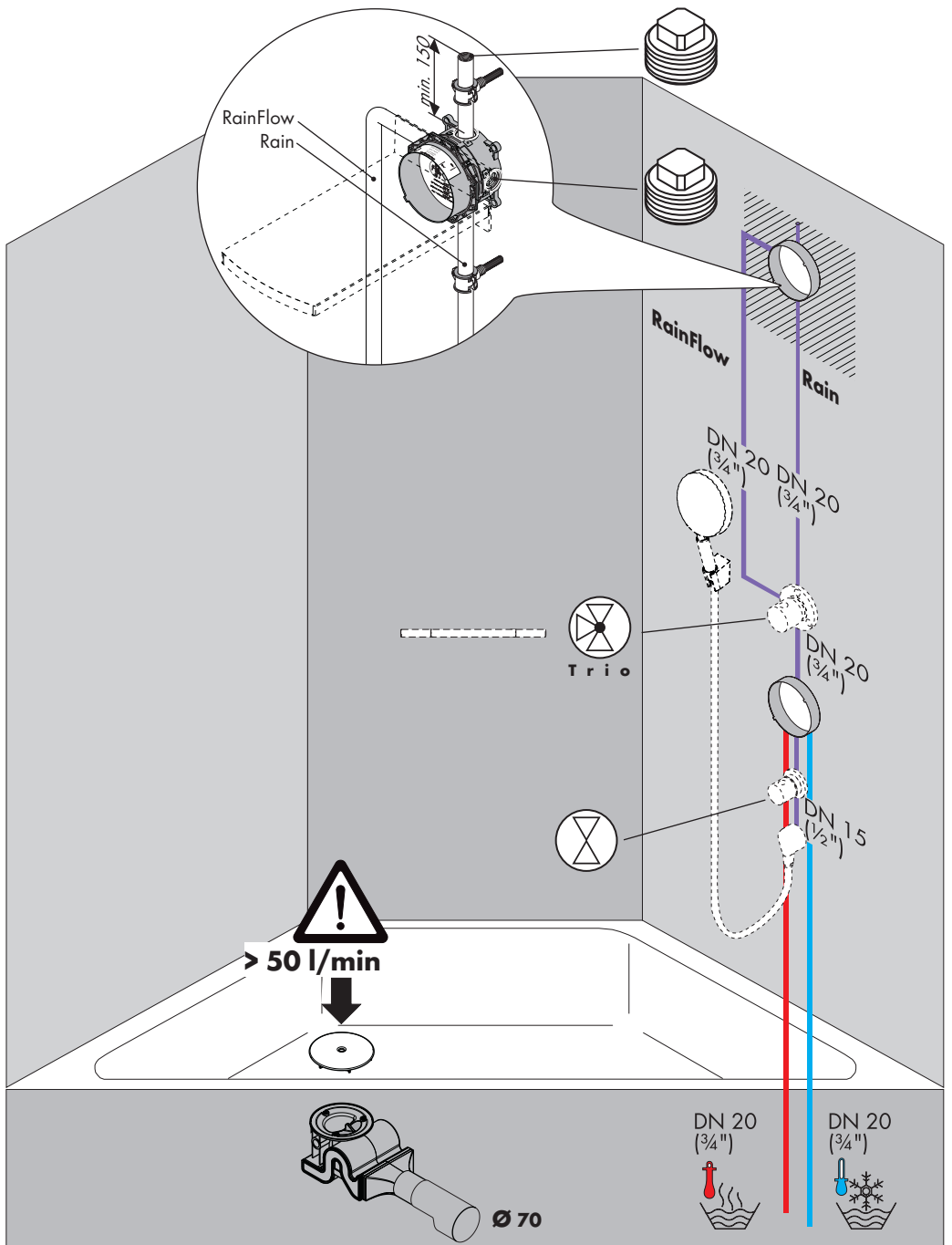

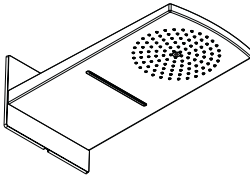
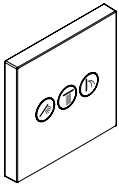

High Flow

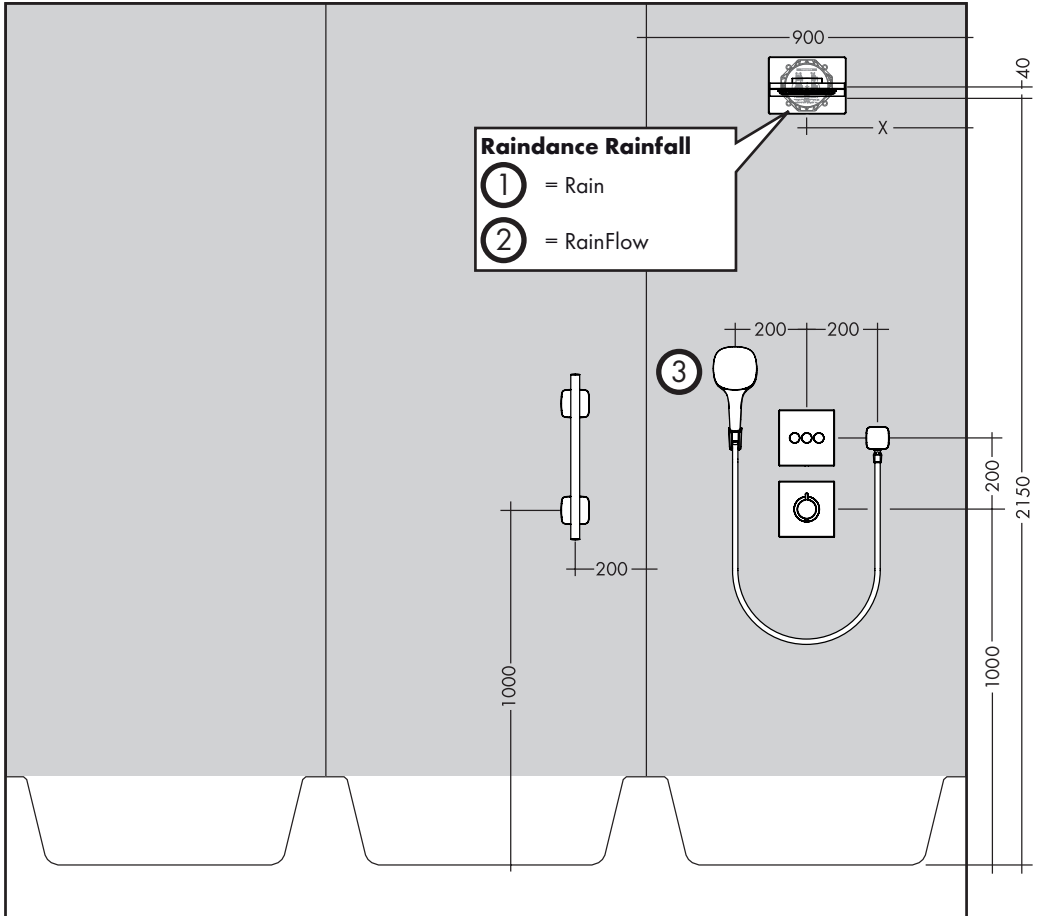
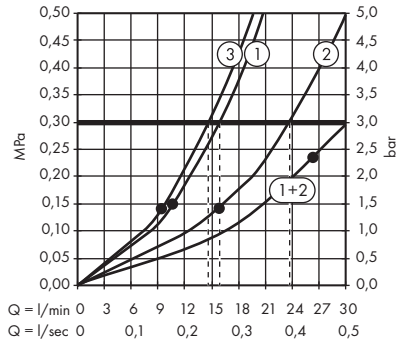
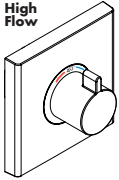

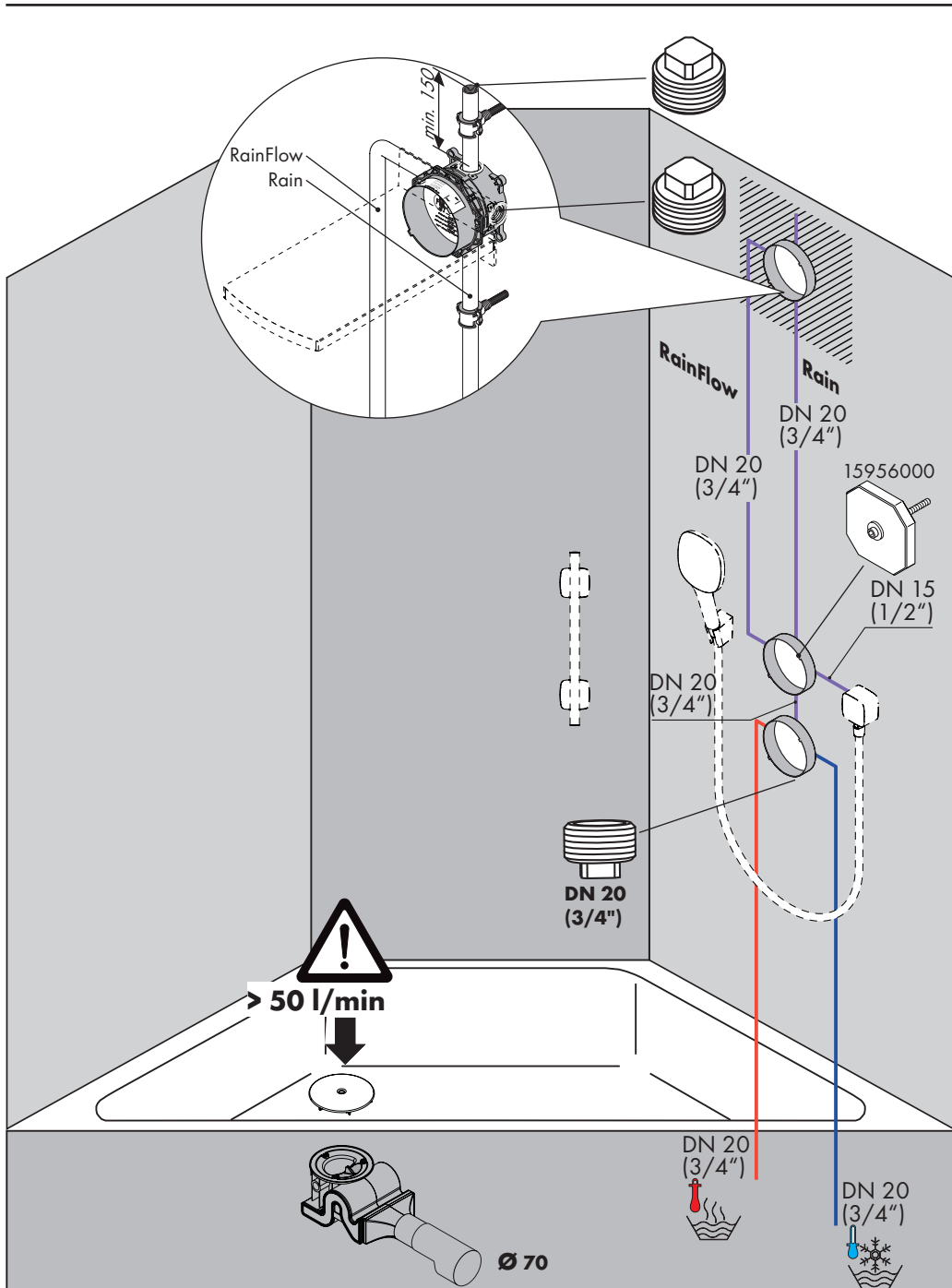

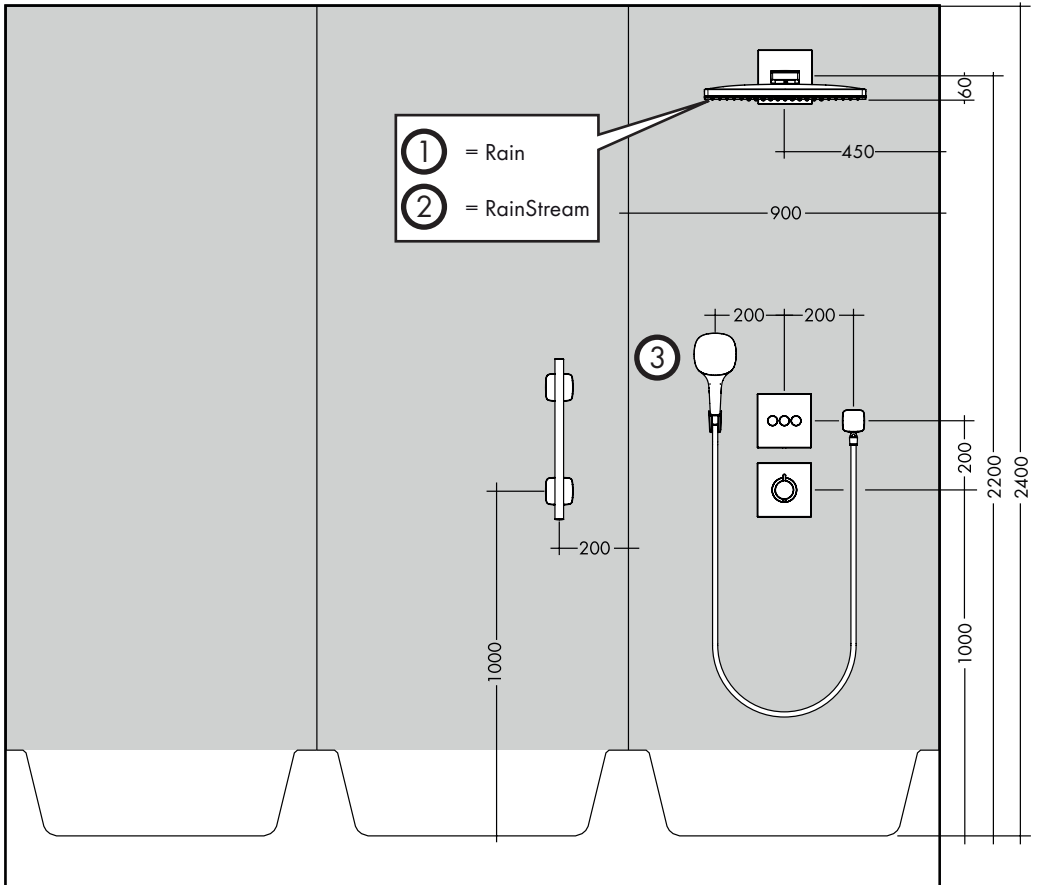
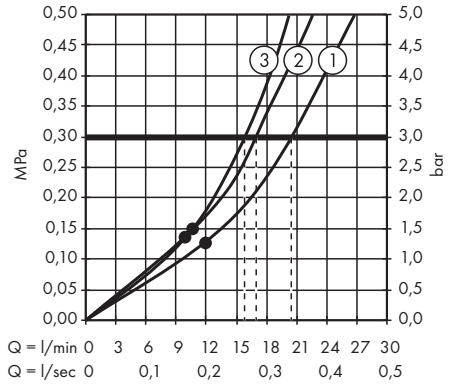
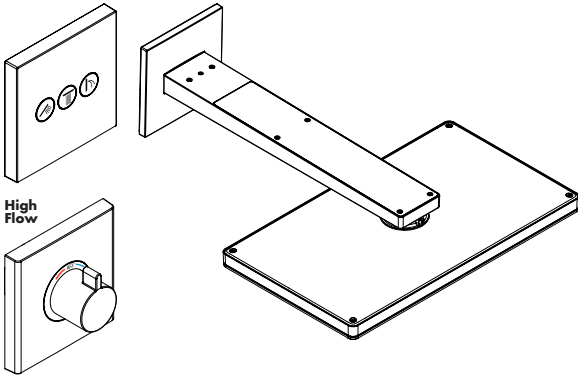

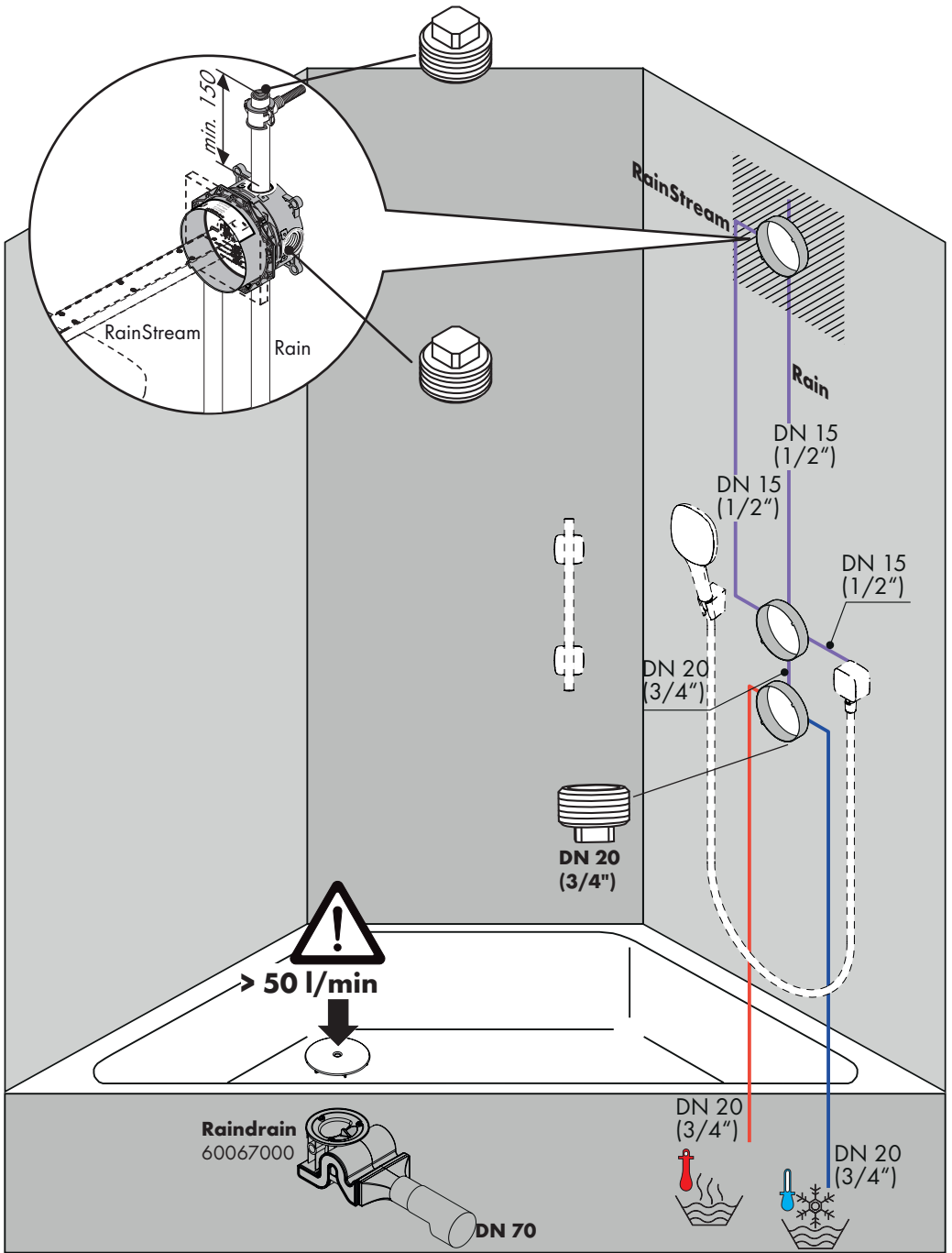

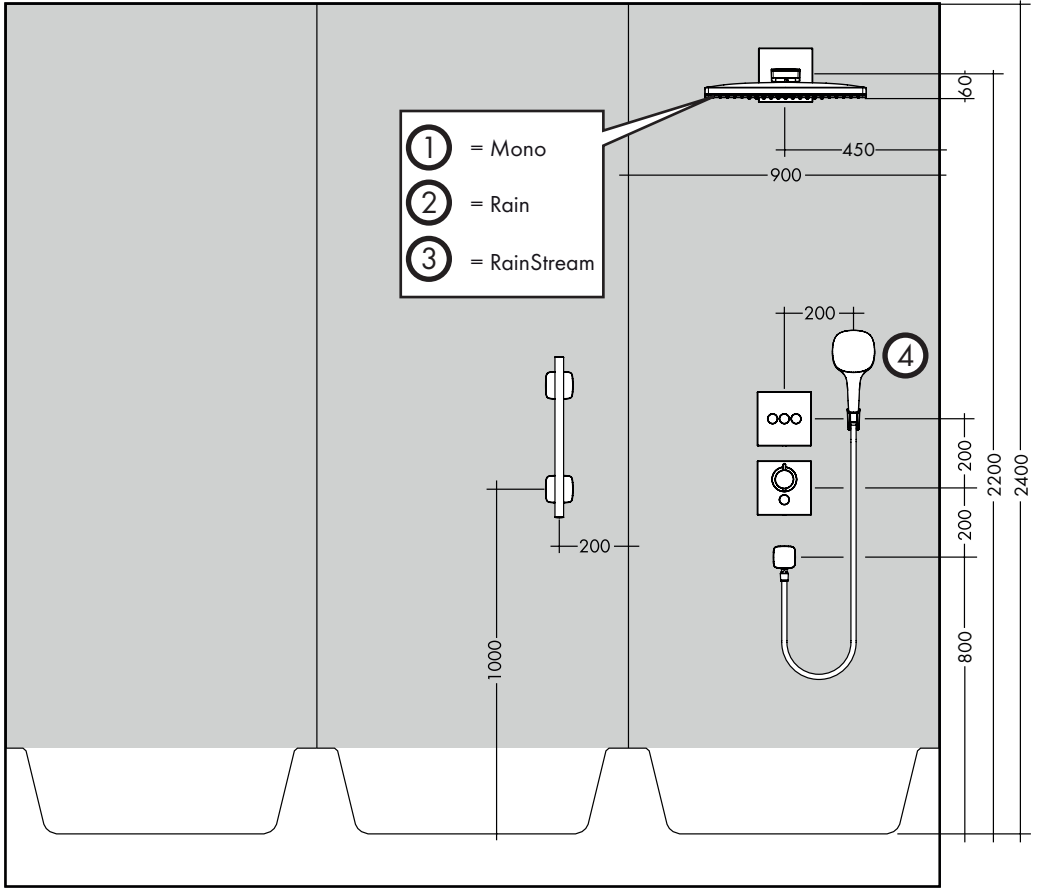
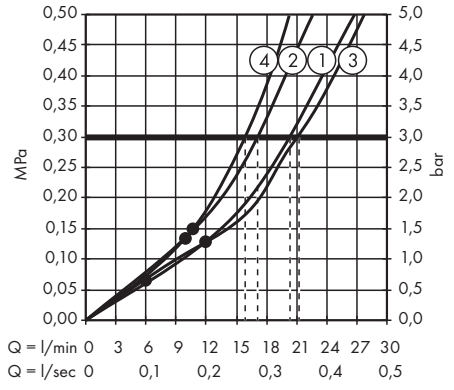
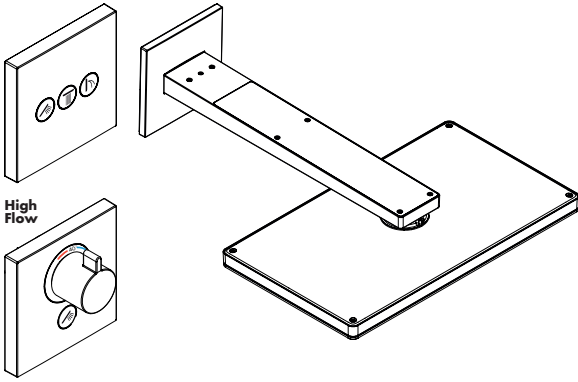

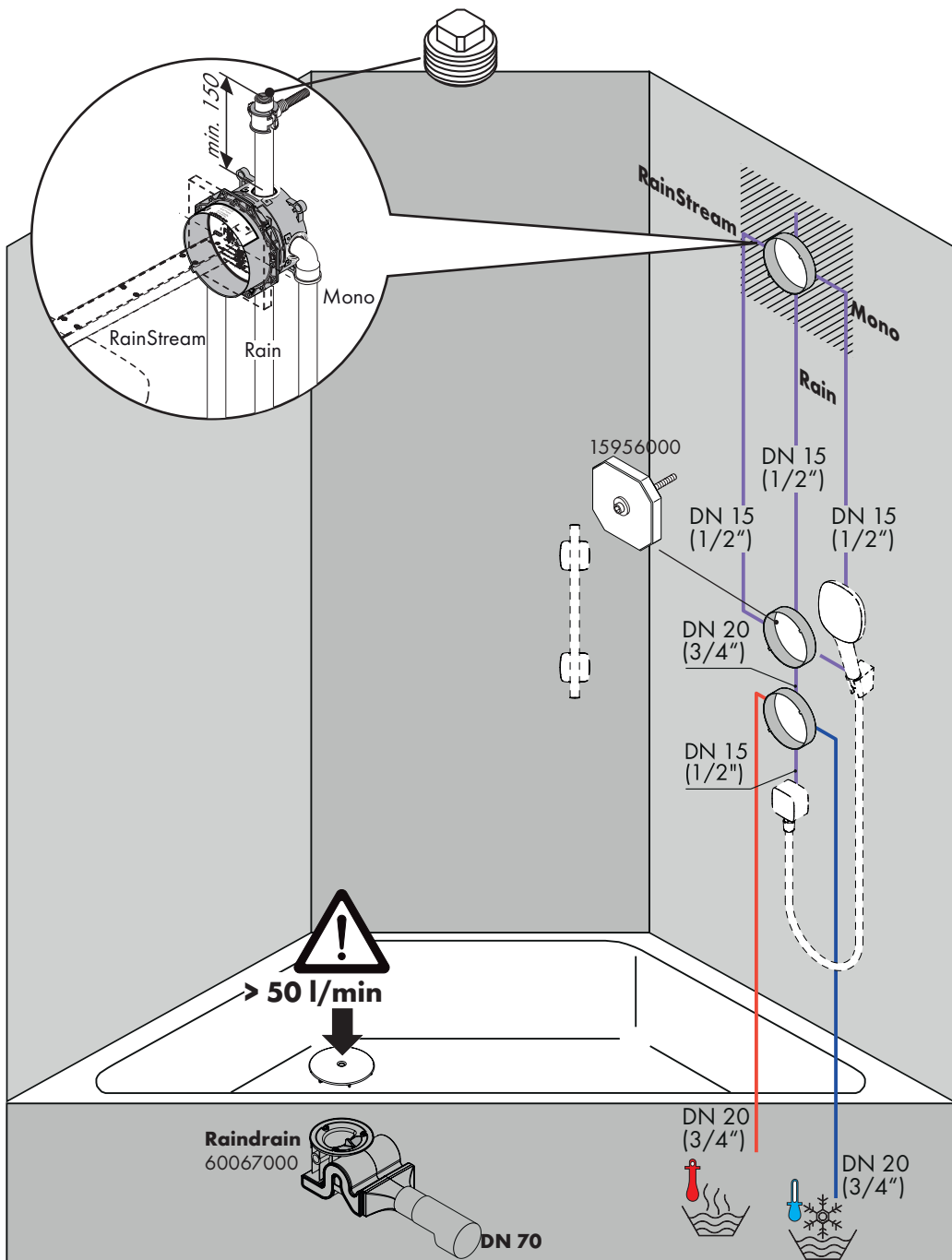









hansgrohe

